

performance
plus

PERFORMANCE IS MY PLUS



www.myperformanceplus.de

CATALOG
2023

Performance wants to know.

**PERFORMANCE GETS YOU IN
THE MOOD MORE THAN USUAL.**

**Performance is about to be
victorious.**

**PERFORMANCE IS PROOF
THAT IT IS POSSIBLE.**

**Performance enables human and
tool to become one.**

PERFORMANCE IS SEXY.

**Performance is when work makes
you proud like never before.**

WELCOME TO PERFORMANCE PLUS:



**The new premium class for
workshop trolleys.**

WE WANT TO REDEFINE THE WORKSHOP TROLLEY PREMIUM CLASS

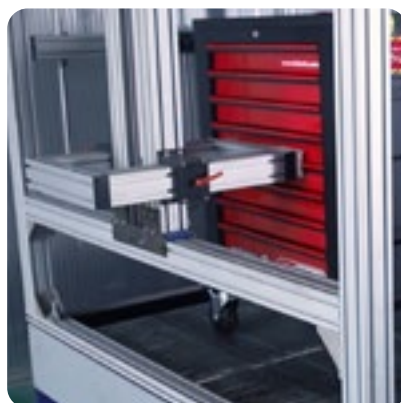

Performance
in moving images

Our mission: The best workshop trolley for industrial, car and commercial vehicle mechanics and for individuals with the most exacting demands.

We deliver more than we promise:

**CONSTRUCTED TO
MAXIMUM PERFECTION.**

Manufactured to the highest quality.

**GREATEST CONSISTENCY
IN PRICING.**

Non-compromising controls.

**THREE YEARS
INTENSIVE DEVELOPMENT.**

A yellow sports car is elevated on a blue hydraulic lift in a workshop. The car is positioned on the right side of the frame. In the background, there is a brick wall and a window. A red tool chest with 'KS TOOLS' branding is visible on the right. The floor is made of grey tiles.

CONSTRUCTED BY DIE-HARD PERFECTIONISTS

Open drawer. Close drawer. Press the Duo Lock switch. Two drawers open simultaneously. Smooth as butter. No sticking, no creaking.

The Duo Lock, which all Performance Plus are equipped with, is a good example of our construction principles. It starts with an idea which makes the world of the workshop that little bit better. Then we work on the technical

implementation of this idea until we really have achieved perfection.

Only then can the Performance Plus rating plate be added to the trolley.

performance
plus



www.kstools.com

DOV-JACK

performance *P* plus

KS TOOLS

AN IDEA THAT MAKES THE WORLD THAT LITTLE BIT BETTER: DUO LOCK

**Sometimes the performance lies in the detail:
This smart innovation is the result of many years
of manufacturing expertise and intensive
development and is the key to greater efficiency
in daily work.**



UNIQUE ON THE MARKET



**THE SMART IDEA FOR GREATER
FLEXIBILITY IN EVERYDAY LIFE**

2 in 1 DUO-LOCK

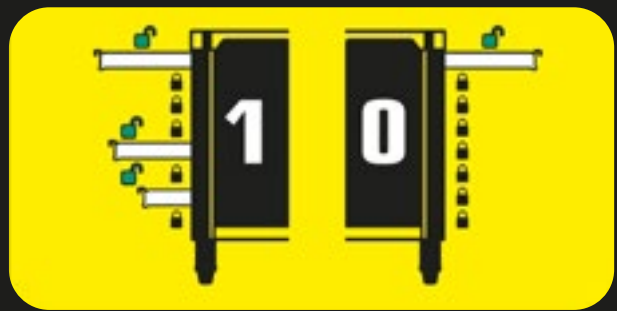

**MINIMAL RISK
OF TILTING**



MAXIMUM ACCESS



**MANUFACTURED
BY RADICAL
QUALITY FETISHISTS**



Open drawer. Close drawer. Open drawer... didn't we just see this text a moment ago? Not quite. Because "open and close" should actually appear 30,000 times. Carried out during the endurance test on one of our test benches.

Components that break during the test never make it into serial production. And, whatever does make it into serial production must demonstrate a consistently high level of quality at regular

intervals during random testing. At the end of the day, this is the difference between irritation and enthusiasm, between a service life of a few years or more than 20.

If you opt for high-quality products, you expect the same level of quality from the service. After all, Performance Plus is just as unique as you and your work.

**ALWAYS
THERE FOR YOU: YOUR
PERFORMANCE ASSISTANT**



Your personal contact kitted out the workshop trolley of your dreams in line with your requirements and checked it over before delivery. Of course, your contact is available to you at any time to answer any questions relating to Performance Plus.

CERTIFIED AND CHECKED

ALL PARTS AND TOOLS

Your guarantee for perfection

A CONTACT

FOR ALL CONCERNS

Round-the-clock availability

KNOWS THE INS AND OUTS OF

YOUR WORKSHOP TROLLEY

CALCULATED BY TOUGH COOKIES



Our experience speaks for itself: Those very customers who invest in a quality-conscious way are the ones who also pay close attention to the price. This is where our cost accountants and purchasers come into play. Because they make every Performance Plus cost-efficient.

They calculate, negotiate and optimise. Over and over again. The deciding factor: Out staff never – and when we say never, we mean never – accept compromises in quality and ultimately in the value that you receive as a customer. Instead, it is calculated, negotiated, and optimized again.

performance
plus



It's sometimes tough and always uncomfortable. But if it makes your decision for Performance Plus easier, then it has been more than worth it.

**IT IS BETTER TO BE SAFE
THAN SORRY.
OUR CHECKS ARE FIRST-
RATE.**



Timeless design, excellent quality, perfect processing. These are our ingredients for workshop trolleys that last for generations. From the initial idea to the final check, we do everything we can to achieve the best possible performance.

LONG-TERM TESTS

FOR ALL CASTORS

Drawers tested 30,000 times at maximum load capacity

48 HOURS OF LONG-TERM LOAD

TESTS FOR ALL COMPONENTS

100% of items checked individually

DELIVERED

FULLY ASSEMBLED AND

EQUIPPED WITH TOOLS

A red classic car, possibly a Ferrari, is shown from a front-three-quarter view with its hood open. The engine is visible, featuring a prominent air filter and various mechanical components. The car is parked in a brick building with large windows in the background. A red banner with white text is overlaid on the lower left portion of the image.

**CHECKED
BY NOTORIOUS
CONTROL FREAKS**



Your Performance Plus is just as unique as you and your work. Let's assume that the Performance Plus you configured includes 555 tools. So, how many do you receive? No, not 555.

But rather 556. Very deliberately. And this is also the only deviation that you can expect. Because the extra item included is a test certificate. It certifies that every single of one the 555 tools selected by you has been positioned in its place correctly. The certificate might be made of paper, but it is our rock-solid proclamation of tested quality. It bears the name, signature and mobile phone

number of a member of our test team, who is personally responsible for your Performance Plus.

This 556th part is therefore your direct line to advice, action and commitment – and might just be the most valuable and powerful tool we supply you with.



“When I joined the Performance Plus construction team, I heard someone say: A job is not well done when it is finished, it is finished when it is well done. That really hits the nail on the head. And the great thing is: Everyone in the team thinks this way. Sometimes you don’t even need to say the words. What people are thinking is in the air: Hey, we can go even further! Then we draw up the plans again and end up with something much better.”

Thomas Tenga,
die-hard perfectionist at KS Tools



“Dubious manufacturing tolerances are often referred to using euphemisms like “manufacture.” That’s not my thing. At KS Tools, we work with state-of-the-art machines and my ambition is to extract as much precision as possible. And then to make even more improvements. And then to improve on that again. So that we can create a premium product like Performance Plus.”

Orhan Altin,
radical quality fetishist at KS Tools



“

“Tough – this is a label I can live with. Because tough is not the same as unfair. I demand a lot from our suppliers, but I never make an enemy of them. For me, Performance Plus is a product created in partnership. KS Tools, our suppliers and our customers all have one thing in com-mon: We all want to create excellence – that will stand the test of time.”

Christian Niebeling,
tough cookie at KS Tools



“

“I am the last in a long line of colleagues who work on a Performance Plus. Everyone before me made such a huge effort to create a great product, which is why I give my all during assembly before the shipping box is closed. So that you can unbox the Performance Plus and get started straight away.”

Thomas Kochhafen,
notorious control freak at KS Tools

FIRST-CLASS FROM EXPERIENCE

20,000 workshop trolleys are proof of this year for year: Longterm success only comes to those who use the best materials. We have taken this principle to the extreme with Performance Plus. The best materials and high-quality equipment ensure that you will still be enjoying your workshop trolley in many years to come.



THE BEST IS GOOD

ENOUGH FOR US

Four steerable castors with brakes

BALL BEARINGS ONLY FROM

RENOWNED MANUFACTURERS

Five years' warranty on all parts



ONLY THE BEST FOR THE BEST

Even the highest quality workshop trolleys are only as good as their inner values. That's why we equip every Performance Plus with the best tools from the KS TOOLS Premium range, which offers more than 45,000 items.

**GUARANTEED QUALITY
MADE BY KS TOOLS**

Thoughtful compilation

**THE RIGHT CHOICE
FOR EVERYONE**

Everything from workshop classics to special tools

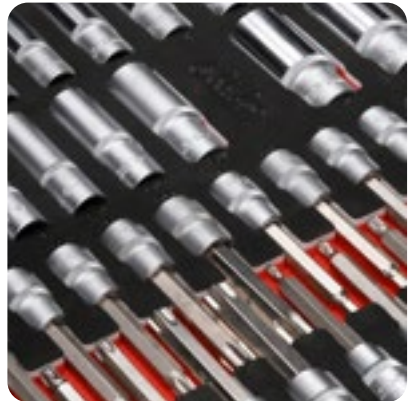
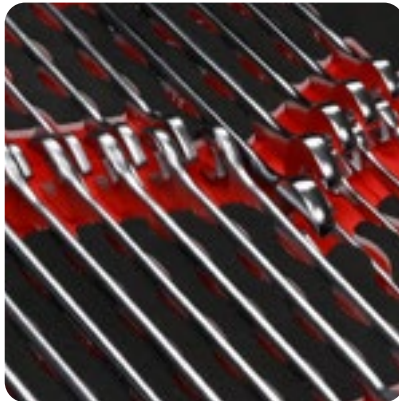

**The best from
45,000 premium
tools**

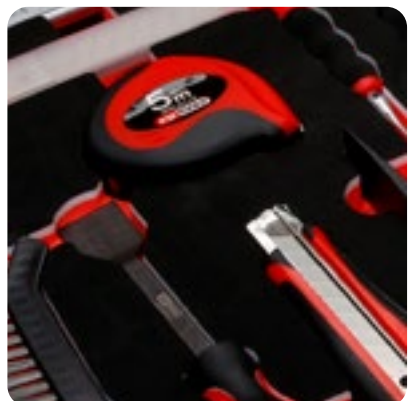
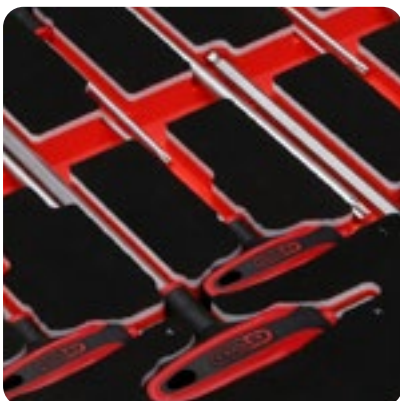
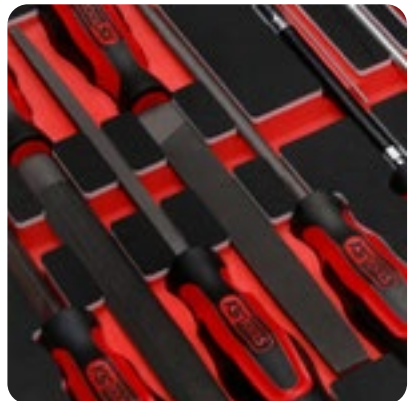

For the Performance Plus workshop trolleys to work, hundreds of individual parts need to work together in perfect harmony.

In order to ensure that your workshop trolley is just as reliable in many years as it is on the day you got it, we guarantee you that every component is interchangeable.

MORE THAN THE SUM OF ITS PARTS



AFTERSALES WARRANTY

ON ALL PARTS

Easy exchange

QUICK AVAILABILITY FOR

CONTINUOUS PERFORMANCE

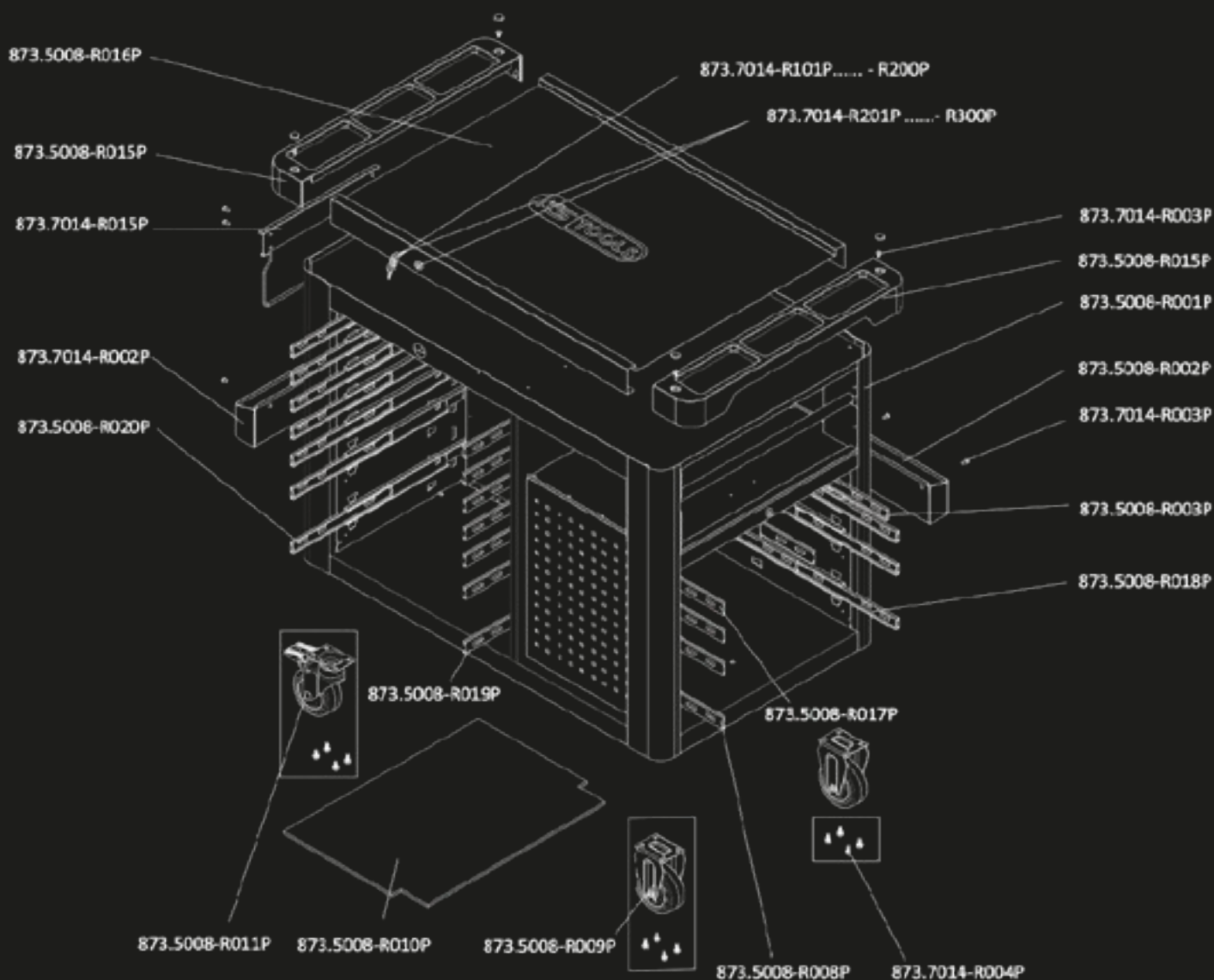

We have designed the drawers of our Performance Plus workshop trolleys in four sizes to cater to individual design options.

The tool inserts are tailored to the drawer sizes based on our experience from decades of tool production.

SUCCESSFULLY THINKING INSIDE THE BOX

**S, M, L, XL: FOUR SIZES FOR
A BETTER OVERVIEW**

**OVER 100 PREASSEMBLED
TOOL INSERTS**

**The combination possibilities are
practically endless**

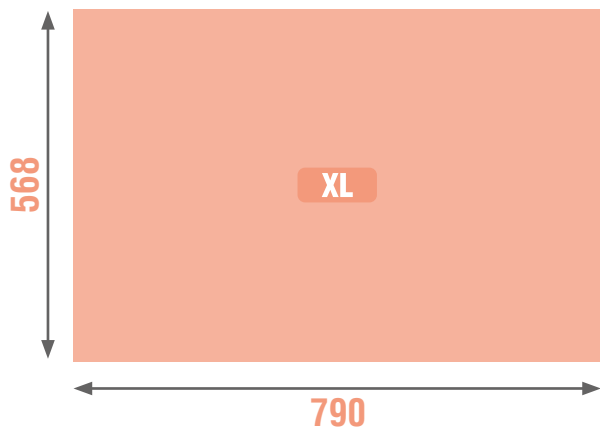
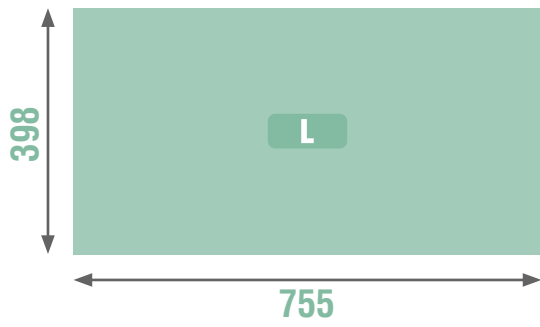
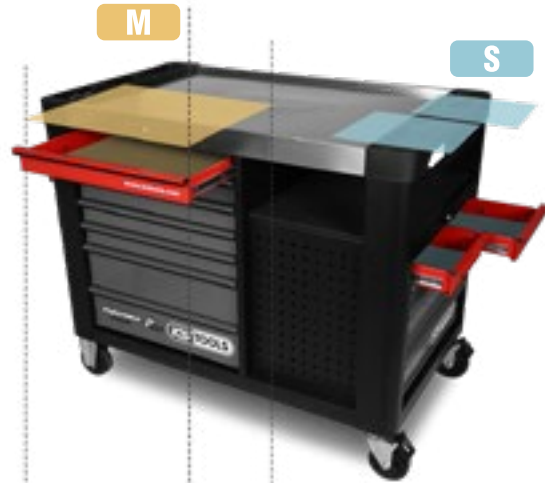
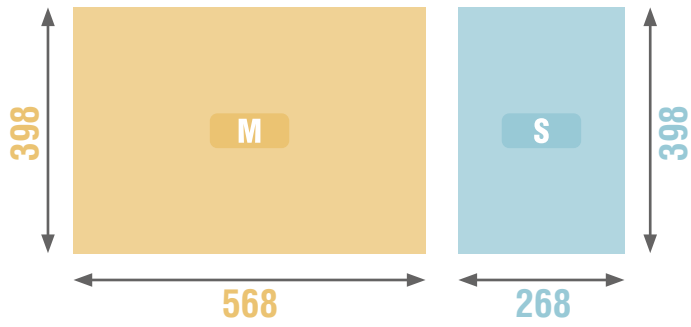

READY FOR USE STRAIGHT AWAY FOR BETTER PERFORMANCE IN SERVICE

**Performance from the first moment:
Every trolley is delivered not only fully
assembled with castors attached,
but also fully equipped with the insert
packages you selected.**

**WELL-THOUGHT-OUT INSERT
PACKAGES FOR ALL APPLICATIONS**

**ALREADY INSERTED
IN YOUR TROLLEY**

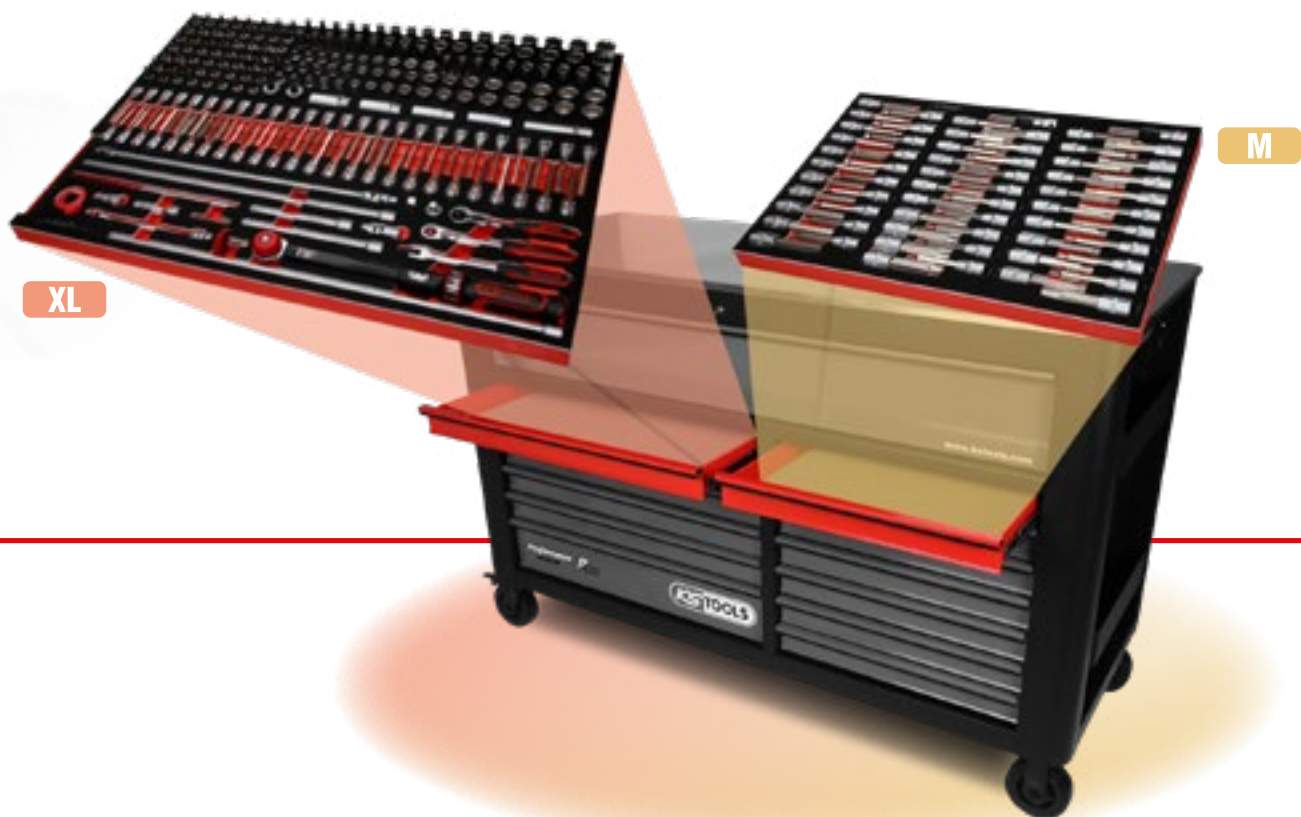

WHICH WORKSHOP TROLLEY IS RIGHT FOR YOU?

How big does it need to be? How many drawers should it have and which drawer size would be ideal? We have developed nine workshop trolleys for you. The most important features are displayed in the matrix below.

ALL GUARANTEED TO INCLUDE EX WORKS:
HIGH QUALITY THAT YOU WILL CONTINUE TO
ENJOY IN MANY YEARS TO COME

	P10	P10TC	P15	P20	P25	P30	P35	P40	P45
Dimensions (W x H x D)	853 x 1024 x 527	853 x 454 x 527	845 x 1023 x 516	1067 x 1023 x 646	1040 x 1024 x 527	1075 x 1024 x 657	1232 x 1027 x 741	1701 x 1017 x 710	1701 x 1132 x 710
No. of drawers	8	4	8	8	8	8	8	4	14
Drawer formats	2	1	2	2	2	2	3	1	4
Drawer internal dimensions	568 x 398 x 65 568 x 398 x 145	568 x 398 x 65	568 x 398 x 65 568 x 398 x 145	785 x 568 x 65 785 x 568 x 145	755 x 398 x 65 755 x 398 x 145	785 x 568 x 65 785 x 568 x 145	268 x 398 x 65 568 x 398 x 65 568 x 398 x 145	1429 x 568 x 180 1429 x 568 x 145	1429 x 568 x 180 568 x 568 x 65 785 x 568 x 65 785 x 568 x 145
Max. load capacity in kg	600 kg	400 kg	600 kg	600 kg	600 kg	600 kg	600 kg	1000 kg	1000 kg
Stainless steel worktop	•	•			•	•	•	•	•
DUO-Lock	•	•	•	•	•	•	•	•	•
Lockable	1x	1x	1x	1x	1x	1x	2x	1x	1x

CONTENT



page 34

P10

With tool inserts
from page 68



page 40

P15

With tool inserts
from page 88



page 44

P20

With tool inserts
from page 108



page 48

P25

With tool inserts
from page 110



page 52

P30

With tool inserts
from page 120



page 56

P35

With tool inserts
from page 122



page 60

P40



page 64

P45

With tool inserts
from page 126

from page 132

Individual parts

from page 154

Accessories

P 10

P 15

P 20

P 25

P 30

P 35

P 40

P 45

Individual parts

Accessories

Workshop trolley P10

with 8 compartments

873.0008

THE ENTRY MODEL TO SATISFY HIGH STANDARDS



► **Performance in comfort:**

Preassembled insert packages with the best tools for almost every application for the P10 can be found from page 68

P10

898,⁹⁰
EUR



DUO Lock Brilliant locking system



Eight drawers each load capacity up to 50 kg



Stable **ball bearing**



Stainless steel surface



Lock lockable



Anti-static castors with brakes

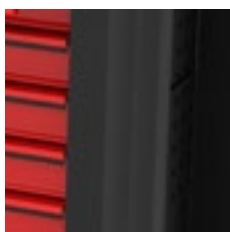

Integrated **corner protection**



Paper roll holder included



Can holder included

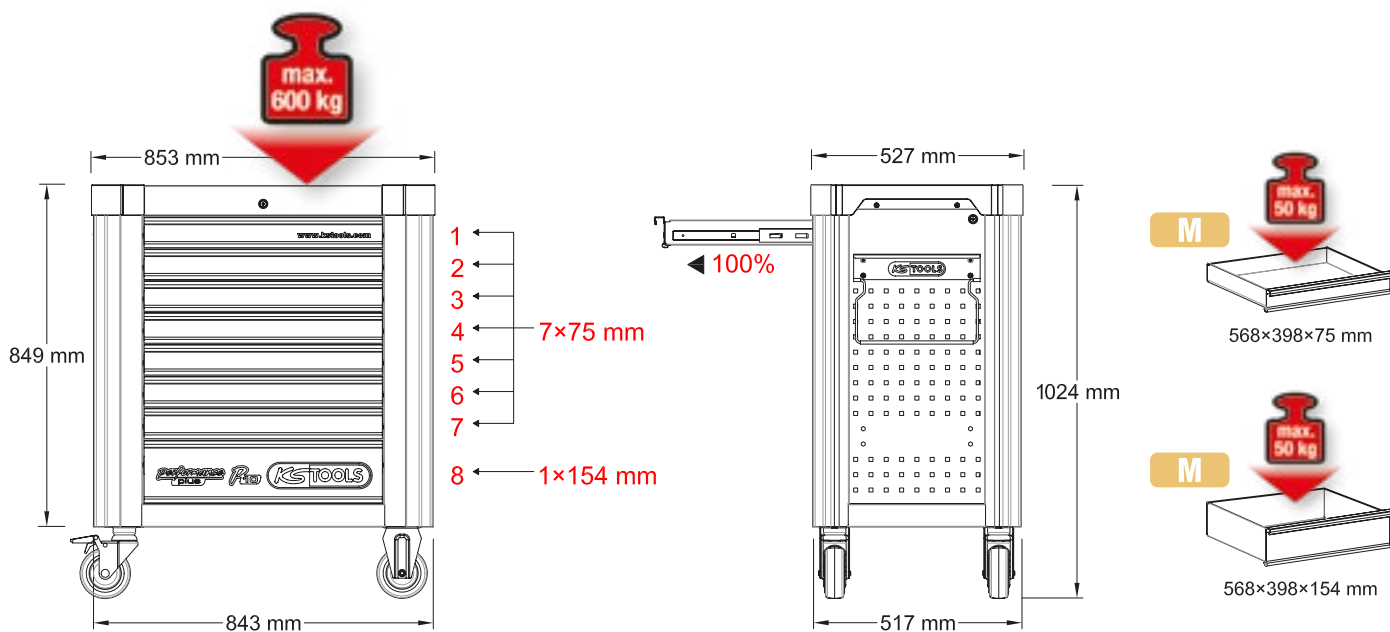

Workshop trolley attachment P10TC

with 4 compartments

873.0004

AND ON TOP OF THAT!



P10TC

588,⁵⁰
EUR



DUO Lock Brilliant
locking system



Four drawers each
load capacity up to 50 kg



Stable
ball bearing

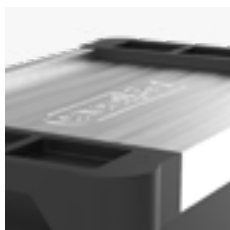

Stainless steel surface



Lock
lockable



Stable grip
easy to transport

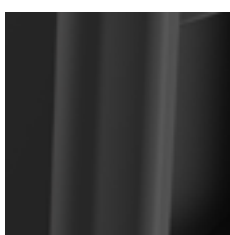

Integrated
corner protection

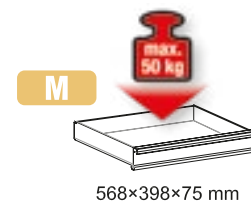
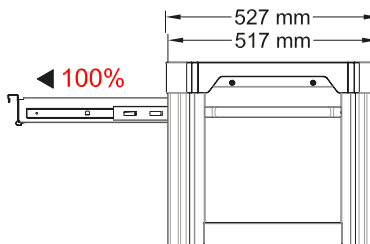
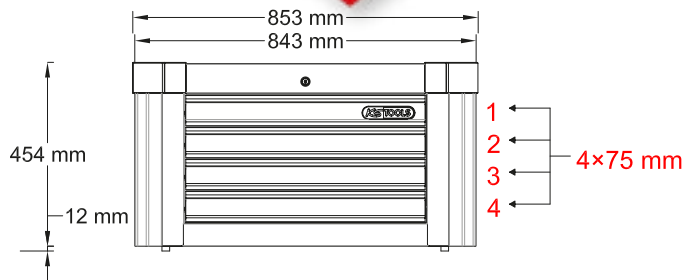

P 10

P 15

P 20

P 25

P 30

P 35

P 40

P 45

Individual parts

Accessories



performance
plus



**PERFORMANCE IS
YOUR PLUS!**

THE COMPACT HEAVYWEIGHT

P15



► Quick & Easy

Want to get started right away? Then why not opt for our preassembled insert packages for almost any application, for the P15 from page 88

Workshop trolley P15
with 8 compartments
873.1008

1.069,⁹⁰



DUO Lock Brilliant locking system



Eight drawers each load capacity up to 50 kg



Stable **ball bearing**



Plastic Surface

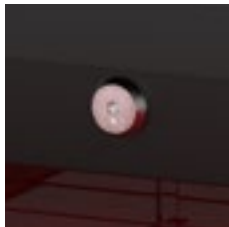

Lock lockable



Anti-static castors with brakes



Integrated **corner protection**



Paper roll holder included



Can holder included

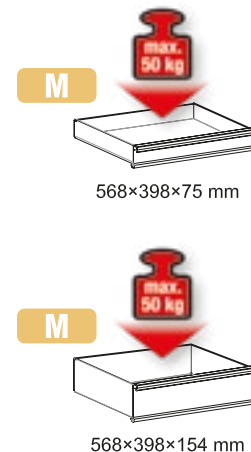
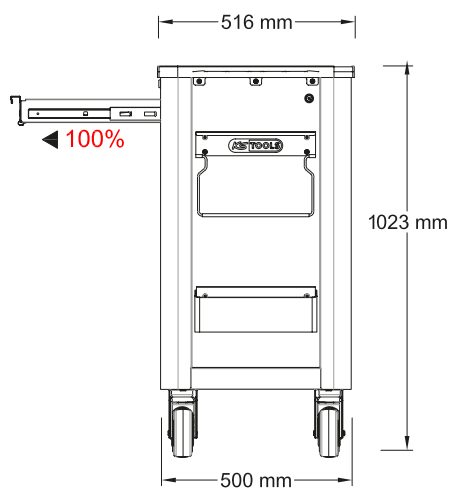
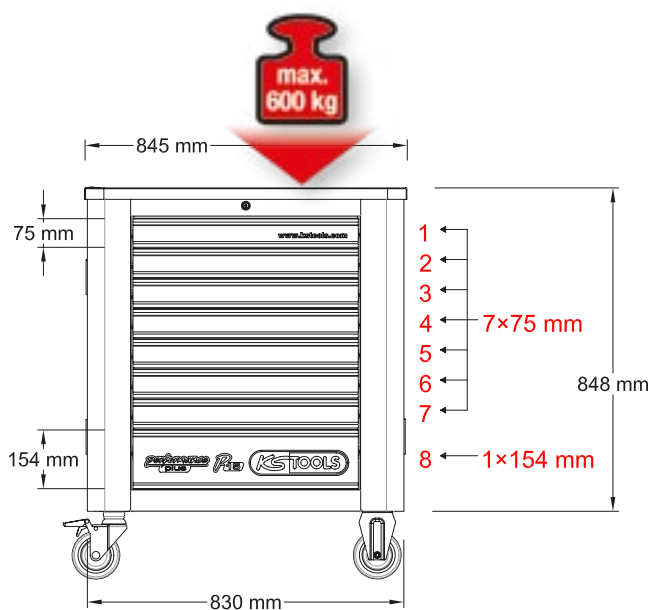

An aerial, high-angle view of a race track curving through a lush, green landscape. Two race cars, one red and one green, are visible on the track, navigating a sharp bend. The track is bordered by a concrete wall and a red-and-white striped curb. The background features rolling hills, trees, and a small waterfall. A large red banner with white text is overlaid on the upper portion of the image.

JUST ONE LAST BEND AND OUR TEAM WILL SPRING INTO ACTION.

Even though we aren't in the driving seat of a race car and there is no team order or imminent wheel changes – we are still here with you.

Because we are there for our users. Here at KS Tools, we are a united team, with all our expertise, our passion and our responsibility for the moment when it really matters. Our mission: to provide first-class tools to front-line users. At the races on Sunday, at your company from Monday.

performance
plus



MORE WIDTH, MORE DEPTH, MORE TOOLS

P20



► **Performance in a package**

Our insert packages contain the perfect mix of tools. Especially for the P20 from page 108

Workshop trolley P20
with 8 compartments
873.2008

1.390,⁹⁰



DUO Lock Brilliant locking system



8 Drawers each load capacity up to 50 kg



Stable **ball bearing**



Plastic Surface

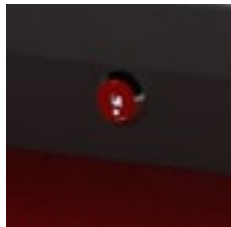

Lock lockable



Anti-static castors with brakes

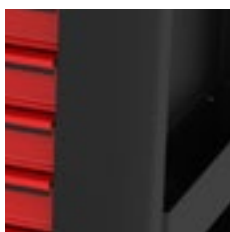

Integrated **corner protection**



Paper roll holder included



Can holder included

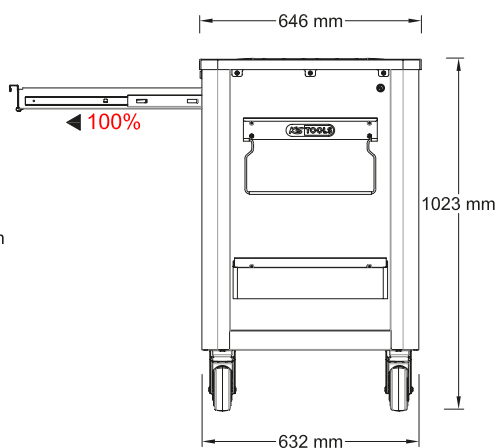
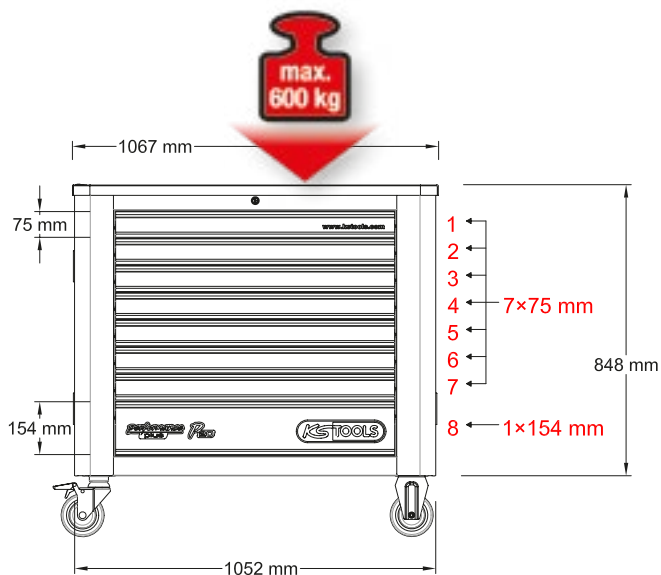



GREEN LEADS, RED WINS

It is well known that races are also won in the pits. Nerves of steel and equipment that can keep up are what matters.

But heroes' stories of maximum performance under high pressure are not just written at Monza and Le Mans.

You can be the protagonist too. With durable precision that can be recognised by the red Performance Plus trolley.

performance
plus



PRECIOUS WIDTH



► **Complete performance**

We have preassembled a series of insert packages for you drawing on our decades of experience. For the P25 from page 110

Workshop trolley P25
with 8 compartments
873.3008

1.048,⁵⁰



DUO Lock Brilliant locking system



8 Drawers each load capacity up to 50 kg



Stable **ball bearing**



Stainless steel surface



Lock lockable



Anti-static castors with brakes

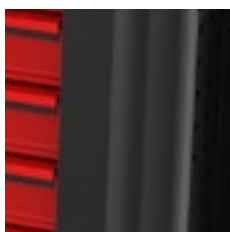

Integrated **corner protection**



Paper roll holder included



Can holder included

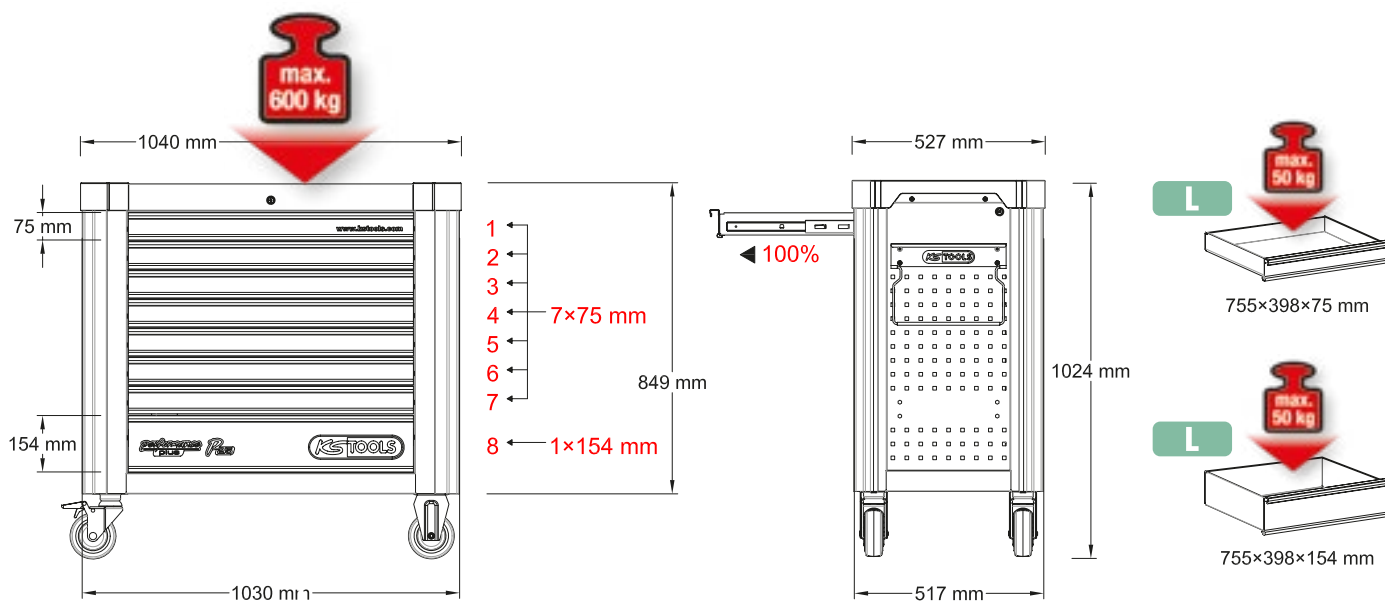

© Porsche GT3
Leidenschaftliche Freude,
präzise umgesetzt



**BORN A CLASSIC.
WITH THE FUTURE
IN ITS GENES.**



A Performance Plus is the workshop trolley that lasts for generations. When they retire, some champions will say goodbye to “their” Performance Plus which had been their faithful companion since their apprentice days.

This is exactly why each Performance Plus is given a fantastic timeless design and is exceptionally robust. And what if you lose something over the years?

You can purchase both the individual parts of the trolley and even the smallest tool without any problems at a later date. Performance Plus. A great future on small wheels.

WANT TO GO INTO MORE DETAIL?

P30



► Ready to go

Do you want the necessary tools for your P30 to already be installed in your new workshop trolley? You can find the universal insert package on page 120

Workshop trolley P30
with 8 compartments
873.4008

1.476,⁵⁰



DUO Lock Brilliant locking system



8 Drawers each load capacity up to 50 kg

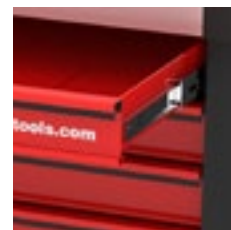

Stable **ball bearing**



Stainless steel surface

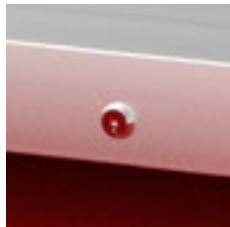

Lock lockable



Anti-static castors with brakes



Integrated **corner protection**



Paper roll holder included



Can holder included

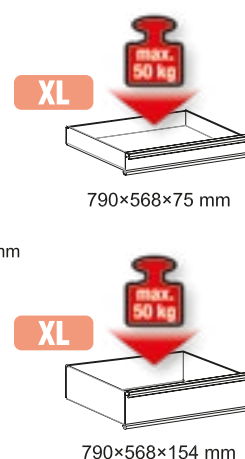
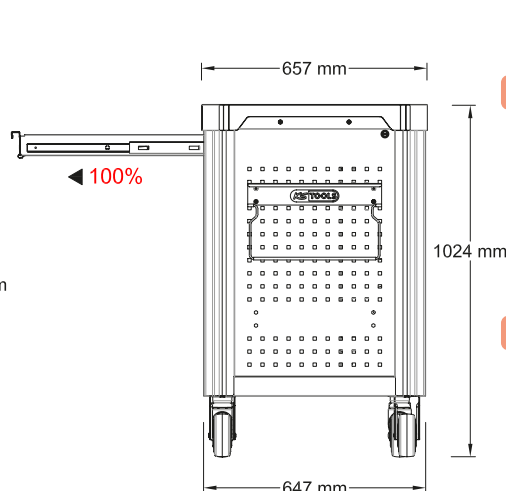
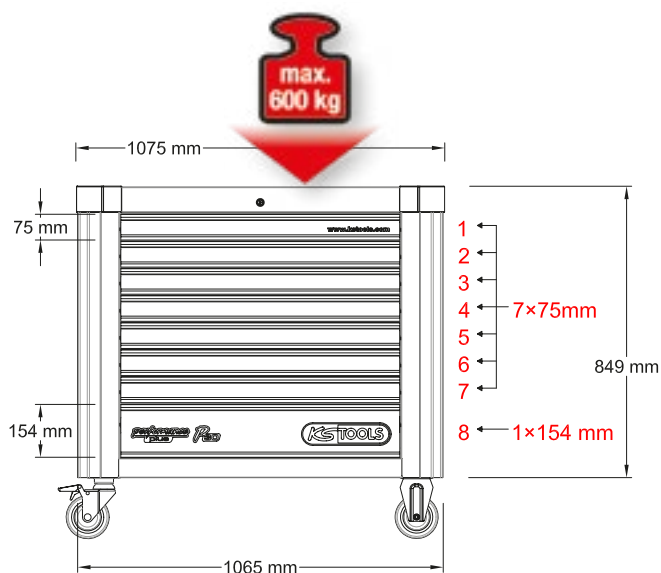



PERFORMANCE ON FOUR WHEELS IS NOT A QUESTION OF TYRE SIZE.

**We have packed a lot into the small, quick wheels of our workshop trolleys:
powerful tools, exemplary ergonomics, a well-engineered overall design and, above all, proven durability.**

For there is one thing we have learnt from motor sport: Success only comes to those who cross the finish line quickly and without any glitches. A future on small wheels.

performance
plus

PERFORMANCE



INNOVATIVE THINKING FOR GREATER EFFICIENCY!



► **Perfect performance**

Choose one of our special insert packages:
The best tools for the P35 from page 122

Workshop trolley P35
with 12 compartments
873.5008

2.139,⁹⁰



DUO Lock Brilliant locking system



Twelve drawers each load capacity up to 50 kg



Stable **ball bearing**



Stainless steel surface

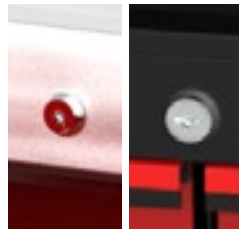

Two locks lockable



Anti-static castors with brakes



Integrated **corner protection**



Paper roll holder included



Can holder included

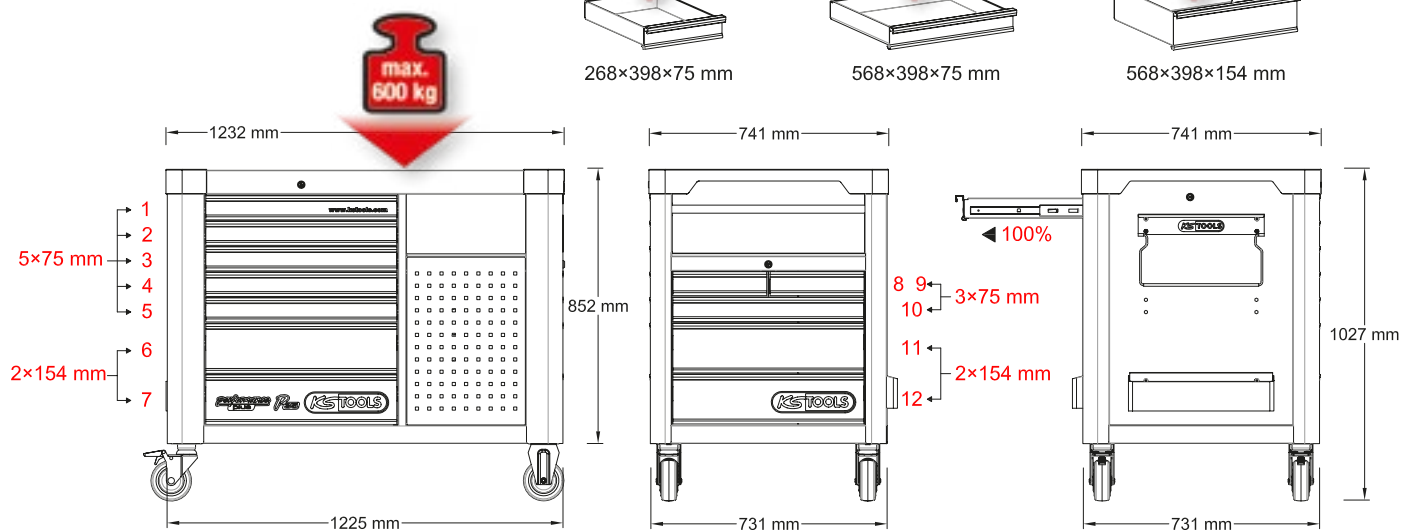
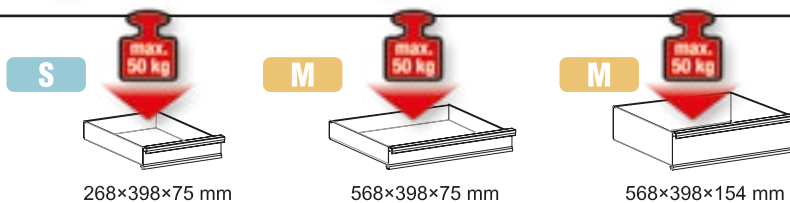



**PERFORMANCE
IS UNIQUE!**

performance
plus



www.kstools.com

KS TOOLS

P25

HIGH DRAWERS FOR THE HIGHEST DEMANDS

P40



Workshop trolley P40
with 4 compartments
873.6008

2.760,⁵⁰



DUO Lock Brilliant locking system



Four drawers each load capacity up to 65 kg



Stable **ball bearing**

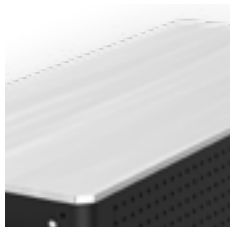

Stainless steel surface

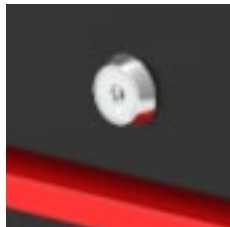

Lock lockable



Anti-static castors with brakes



Integrated **corner protection**



Paper roll holder included



Can holder included

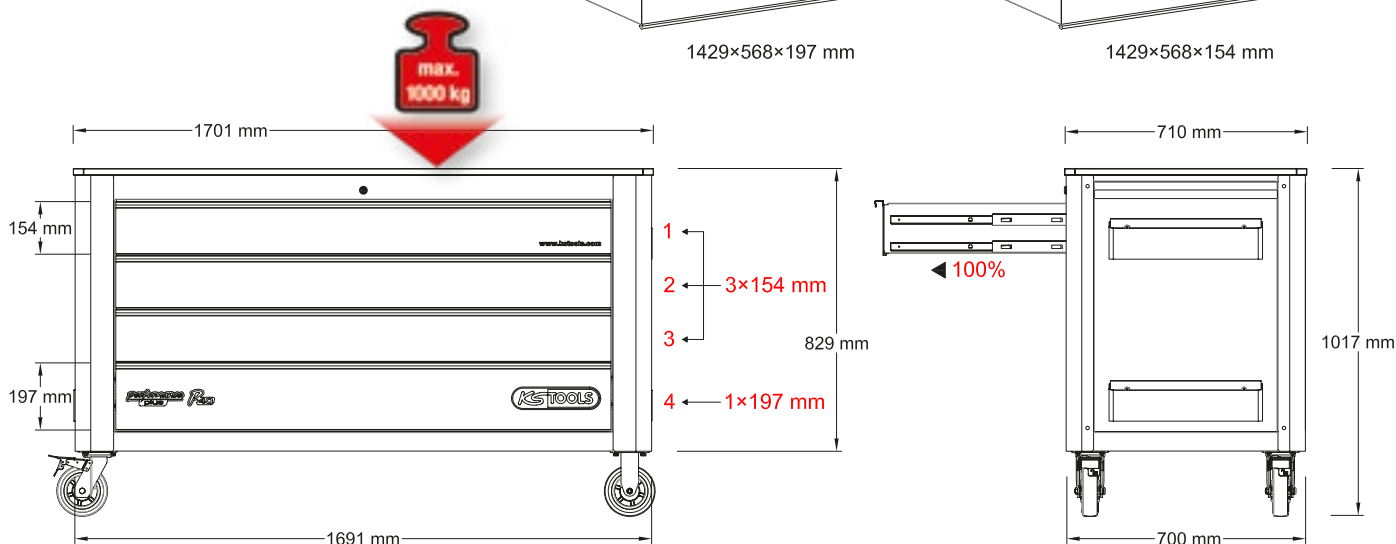
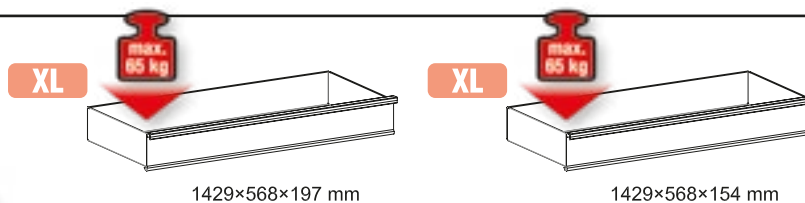



[www.ksto](http://www.ksto.com)

performance **P₁₀** **KS TOOLS**
plus

performance
plus

ols.com

OLS

**PERFORMANCE
BREEDS
SUCCESS!**

THE SPACESHIP OF YOUR DREAMS FOR THE WORKSHOP!

P45



► **Fantastic performance**

Insert packages for the P45, put together by drawing on our dec-ades of experience, from page 126

Workshop trolley P45
with 15 compartments
873.7014

3.156,⁵⁰



DUO Lock Brilliant locking system



Fourteen drawers each load capacity up to 65 kg



Stable **ball bearing**

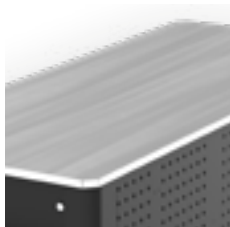

Stainless steel surface

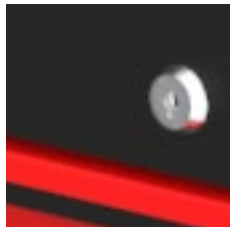

Lock lockable



Anti-static castors with brakes



Integrated **corner protection**



Paper roll holder included



Can holder included

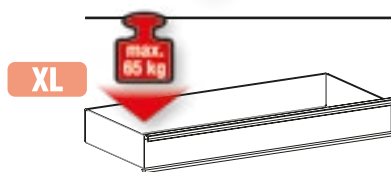

1429×568×197 mm

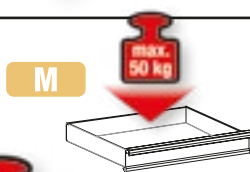

568×568×75 mm

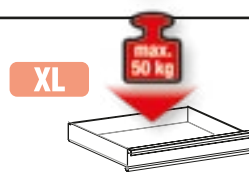

790×568×75 mm

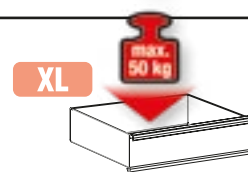

790×568×154 mm

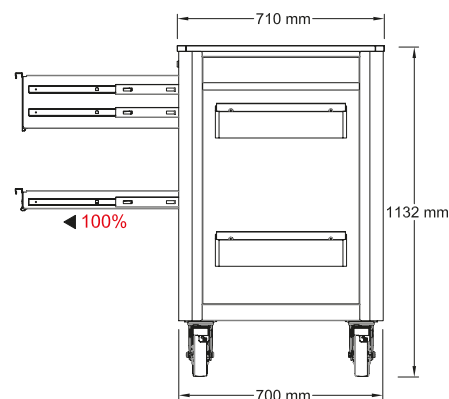
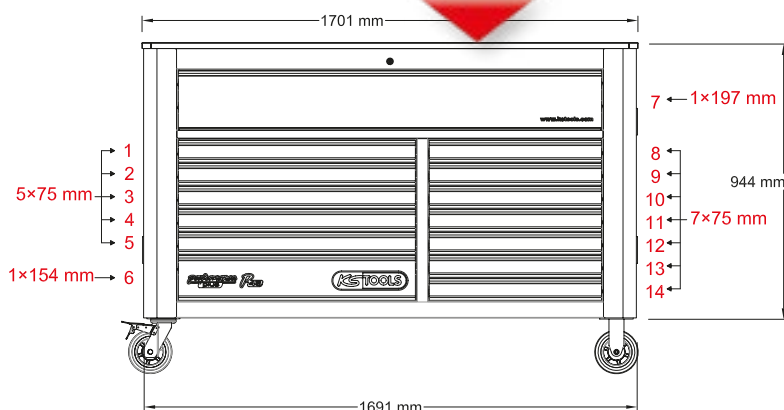

PERFORMANCE IN A PACKAGE

**Performance from the very first moment:
Every trolley is delivered not only fully
assembled with castors attached, but
also fully equipped with the insert
packages you selected.**

WELL-THOUGHT-OUT INSERT

PACKAGES FOR ALL APPLICATIONS

ALREADY INSERTED

IN YOUR TROLLEY



45 DIFFERENT INSERT PACKAGES

CONTENT



P10

P10 Workshop trolley pages
for 4 drawers 68 - 69
for 5 drawers 70 - 72
for 6 drawers 73 - 79
for 7 drawers 80 - 85
for 8 drawers 86 - 87



P15

P15 Workshop trolley pages
for 4 drawers 88 - 89
for 5 drawers 90 - 92
for 6 drawers 93 - 99
for 7 drawers 100 - 105
for 8 drawers 106 - 107



P20

P20 Workshop trolley pages
for 9 drawers 108 - 109



P25

P25 Workshop trolley pages
for 4 drawers 110
for 6 drawers 111 - 112
for 7 drawers 114 - 115
for 8 drawers 116 - 119



P30

P30 Workshop trolley pages
for 7 drawers 120 - 121



P35

P35 Workshop trolley pages
for 5 drawers 122
for 12 drawers 124 - 125



P45

P45 Workshop trolley pages
for 7 drawers 126 - 127
for 13 drawers 128 - 131

P10 workshop tool trolley set with 241 tools for 4 drawers

810.4241



IPCS
241

M

BUNDLE PRICE!

**4 x M
241 pcs**

1.786,⁹⁰ EUR
810.4241

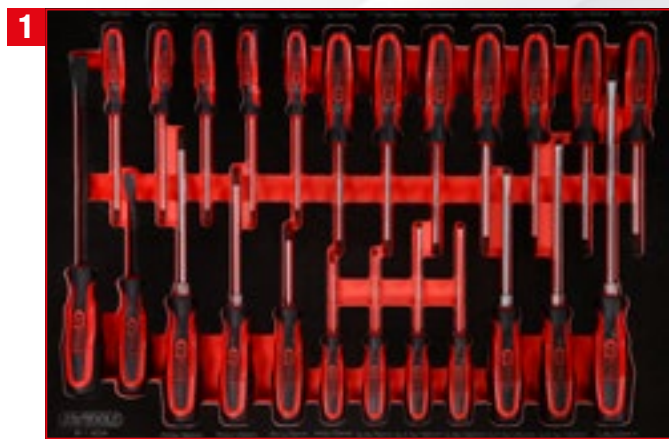

Screwdriver set in foam insert

811.0024

IPCS
24



1/4" + 3/8" + 1/2" socket spanner set in foam insert

811.0159

IPCS
159



Screw spanner set in foam insert

811.1041

IPCS
41



Pliers, hammer and chisel set in foam insert

811.0017

IPCS
17

P10 workshop tool trolley set with 180 tools for 4 drawers

810.4180

180
PCS

M



BUNDLE PRICE!

**4 x M
180 pcs**

1.904,⁵⁰ EUR
810.4180

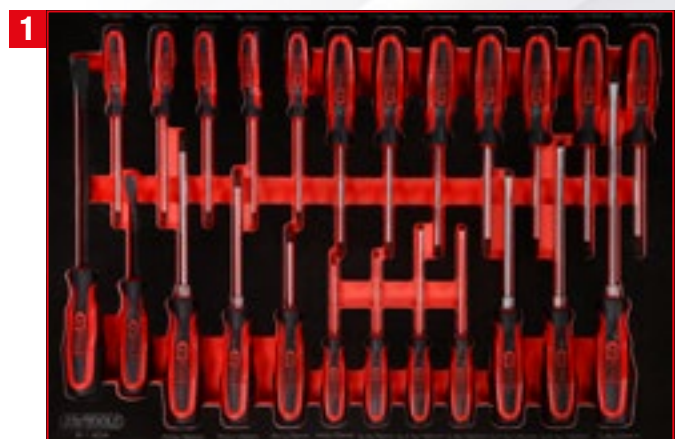

Screwdriver set in foam insert

811.0024

24
PCS



1/4" + 3/8" + 1/2" socket spanner set in foam insert

811.0092

92
PCS



Screw spanner set in foam insert

811.0031

31
PCS



Pliers, hammer and chisel set in foam insert

811.0033

33
PCS

P 10

P 15

P 20

P 25

P 30

P 35

P 40

P 45

Individual parts

Accessories

P10 workshop tool trolley set with 262 tools for 5 drawers

810.5262



M

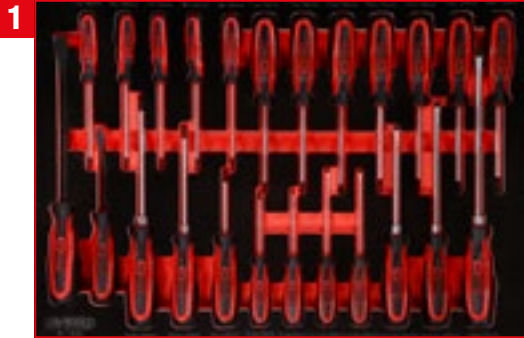

Screwdriver set in foam insert

811.0024

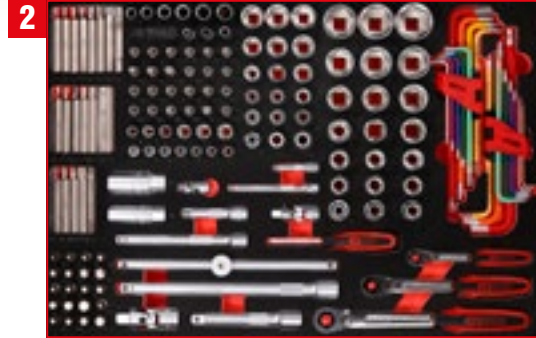

1/4" + 3/8" + 1/2" socket spanner set
in foam insert

811.0159



Screw spanner set in foam insert

811.1040



T-handle and screwdriver set in foam
insert

811.1022



Pliers, hammer and chisel set in foam
insert

811.0017

BUNDLE PRICE!

**5 x M
262 pcs**

**2.139,⁹⁰
EUR**

810.5262

P10 workshop tool trolley set with 279 tools for 5 drawers

810.5279

IPCS
279

M

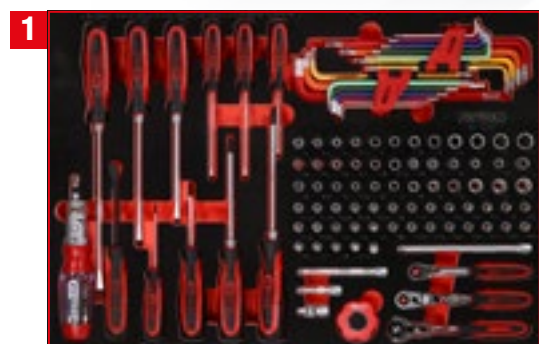

IPCS
105

1/4" socket spanner and screwdriver set in foam insert

811.0105



IPCS
101

3/8" + 1/2" socket spanner set in foam insert

811.0101



IPCS
40

Screw spanner set in foam insert

811.1040

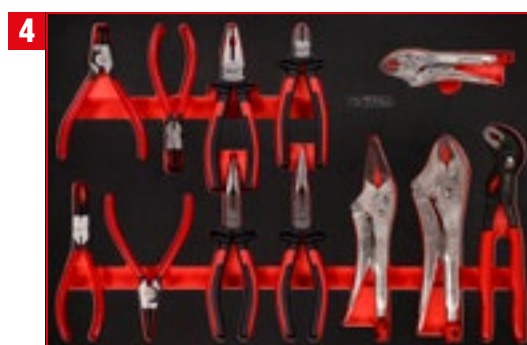

IPCS
12

Spanner set in foam insert

811.0012



IPCS
21

Hammer, chisel and file set in foam insert

811.0021

BUNDLE PRICE!

**5 x M
279 pcs**

2.193,⁵⁰ EUR
810.5279

P 10

P 15

P 20

P 25

P 30

P 35

P 40

P 45

Individual parts

Accessories

P10 workshop tool trolley set with 299 tools for 5 drawers

810.5299



M

BUNDLE PRICE!

5 x M / 299 pcs

2.343,⁵⁰ EUR

810.5299

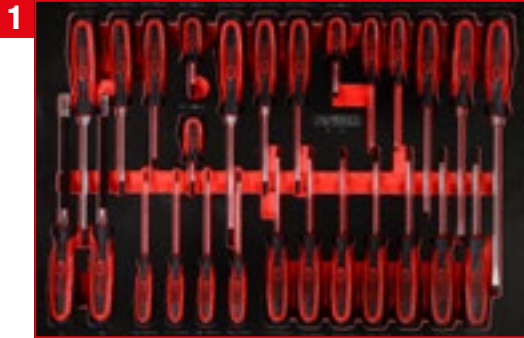

Screwdriver set in foam insert

811.0034

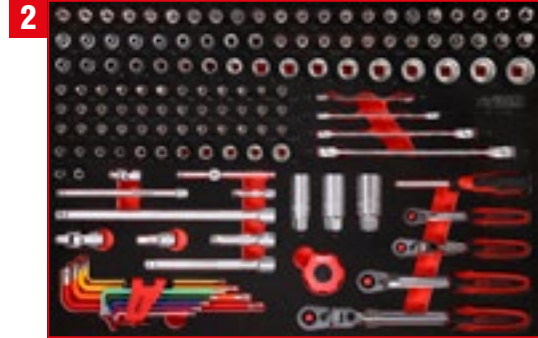

1/4" + 3/8" socket spanner set in foam insert

811.0140



1/2" screwdriver bit set in foam insert

811.0064



Screw spanner set in foam insert

811.0038



Pliers, hammer and chisel set in foam insert

811.1023

P10 workshop tool trolley set with 271 tools for 6 drawers

810.6271



M

BUNDLE PRICE!

6 x M / 271 pcs

2.460,⁹⁰ EUR

810.6271

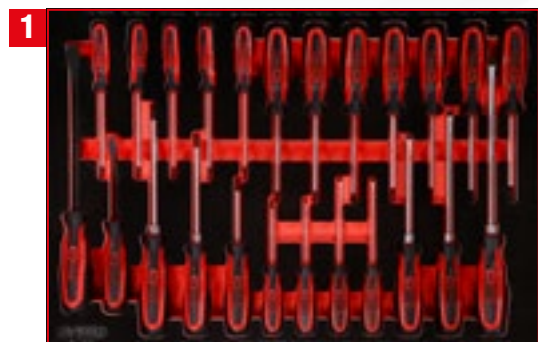

Screwdriver set in foam insert

811.0024



1/4" + 3/8" + 1/2" socket spanner set in foam insert

811.0139



Screw spanner set in foam insert

811.0053



T-handle and screwdriver set in foam insert

811.1022



Spanner set in foam insert

811.0012



Hammer, chisel and file set in foam insert

811.0021

P 10

P 15

P 20

P 25

P 30

P 35

P 40

P 45

Individual parts

Accessories

P10 workshop tool trolley set with 284 tools for 6 drawers

810.6284



M

BUNDLE PRICE!

6 x M / 284 pcs

2.567,⁹⁰ EUR

810.6284

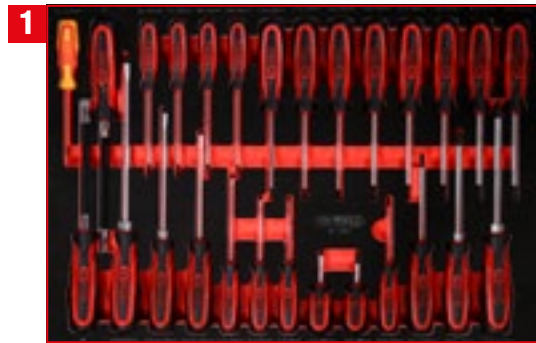

1



Screwdriver set in foam insert

811.0027

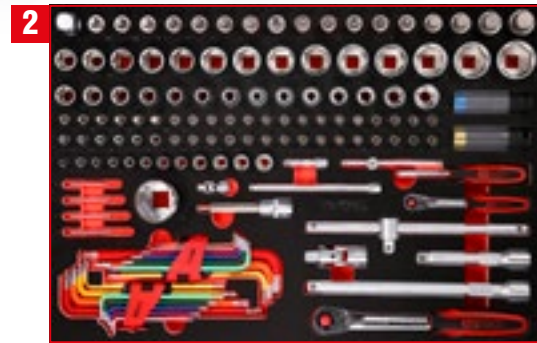

2



1/4" + 1/2" socket spanner set in foam insert

811.1137

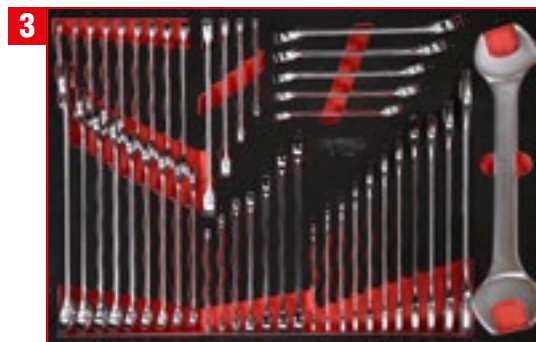

3



Screw spanner set in foam insert

811.0046

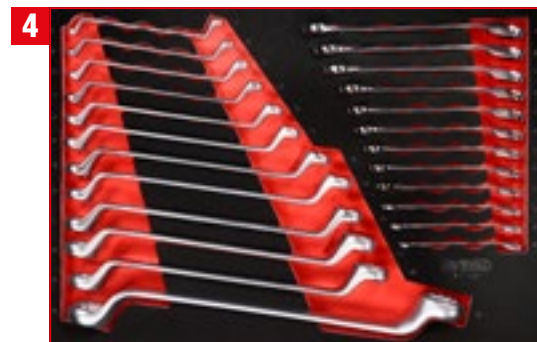

4



Screw spanner set in foam insert

811.1024



5



Pliers and file set in foam insert

811.0019



6



Hammer and chisel set in foam insert

811.0022

P10 workshop tool trolley set with 338 tools for 6 drawers

810.6338



M

BUNDLE PRICE!
6 x M / 338 pcs
2.567,⁹⁰ EUR
 810.6338



IPCS
27

Screwdriver set in foam insert

811.1027

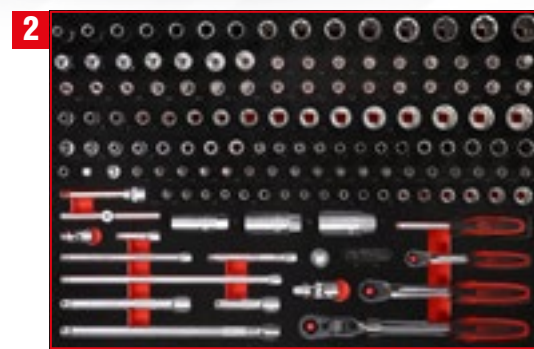

IPCS
142

1/4" + 3/8" socket spanner set in foam insert

811.1142



IPCS
66

1/2" socket spanner set in foam insert

811.0066



IPCS
41

Screw spanner set in foam insert

811.2041

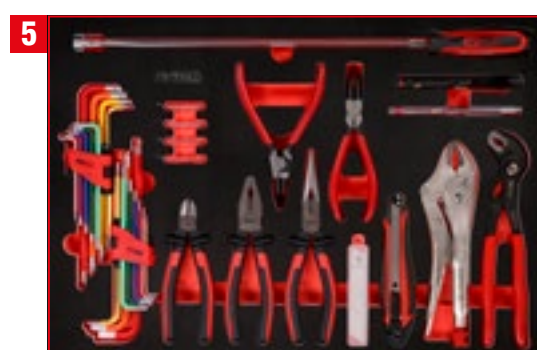

IPCS
45

Pliers and angle spanner set in foam insert

811.0045



IPCS
17

Hammer and chisel set in foam insert

811.1017

P 10
P 15
P 20
P 25
P 30
P 35
P 40
P 45
Accessories Individual parts

P10 workshop tool trolley set with 366 tools for 6 drawers

810.6366

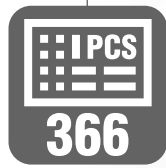

M

BUNDLE PRICE!

6 x M / 366 pcs

2.460,⁹⁰ EUR

810.6366

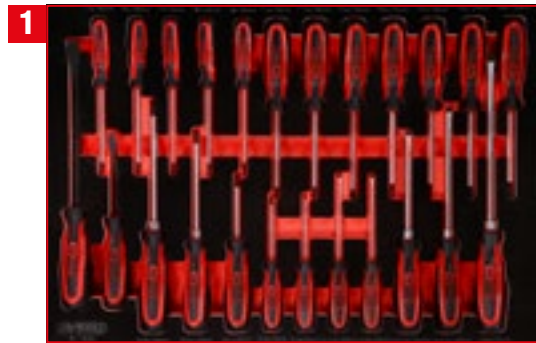

IPCS
24

Screwdriver set in foam insert

811.0024

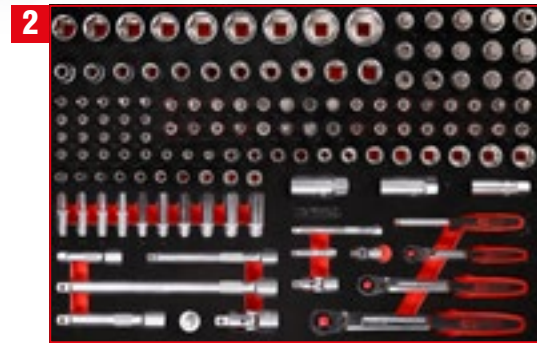

IPCS
139

1/4" + 3/8" + 1/2" socket spanner set in foam insert

811.0139

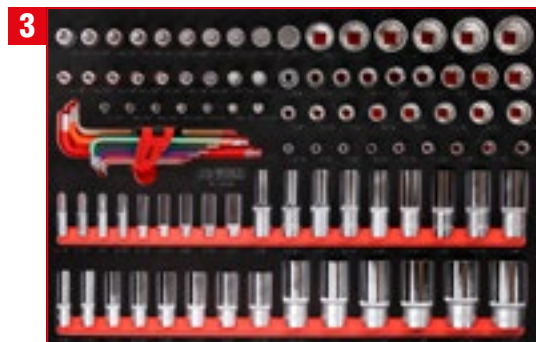

IPCS
99

1/4" + 3/8" + 1/2" socket spanner set in foam insert

811.0099



IPCS
40

Screw spanner set in foam insert

811.1040



IPCS
31

Screw spanner set in foam insert

811.0031



IPCS
33

Pliers, hammer and chisel set in foam insert

811.0033

P10 workshop tool trolley set with 370 tools for 6 drawers

810.6370



M

BUNDLE PRICE!
6 x M / 370 pcs
2.834,⁵⁰ EUR
 810.6370

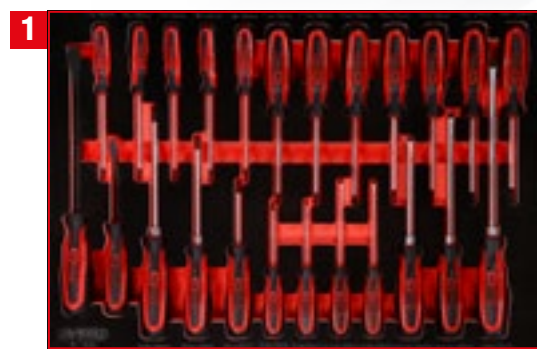

IPCS
24

Screwdriver set in foam insert

811.0024



IPCS
148

1/4" + 3/8" socket spanner set in foam insert

811.0148



IPCS
95

1/2" socket spanner set in foam insert

811.1095



IPCS
53

Screw spanner set in foam insert

811.0053



IPCS
19

Pliers and file set in foam insert

811.0019



IPCS
22

Hammer and chisel set in foam insert

811.0022

P 10
P 15
P 20
P 25
P 30
P 35
P 40
P 45
Accessories Individual parts

P10 workshop tool trolley set with 399 tools for 6 drawers

810.6399



M

BUNDLE PRICE!

6 x M / 399 pcs

2.567,⁵⁰ EUR

810.6399

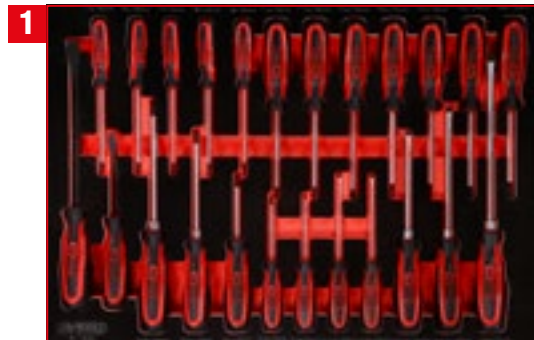

1



Screwdriver set in foam insert

811.0024

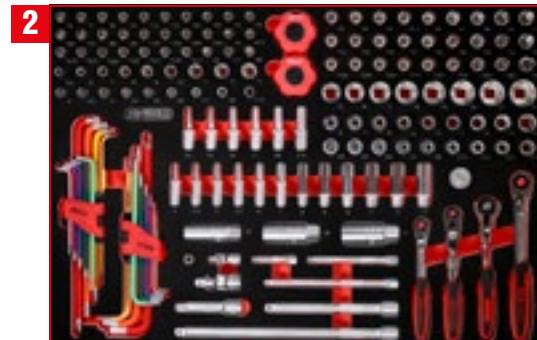

2



1/4" + 3/8" socket spanner set
in foam insert

811.0156

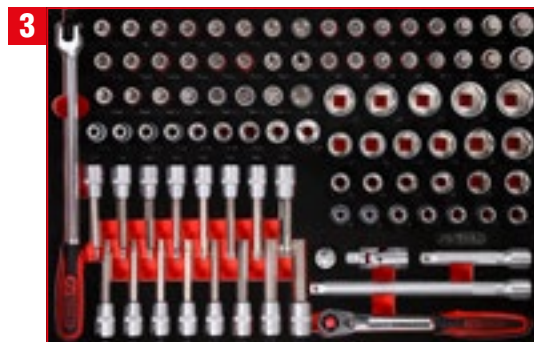

3



1/2" socket spanner set in foam insert

811.0095



4



Screw spanner set in foam insert

811.1040



5



Screw spanner set in foam insert

811.0051



6



Pliers, hammer and chisel set in foam
insert

811.0033

P10 workshop tool trolley set with 423 tools for 6 drawers

810.6423



M

BUNDLE PRICE!

6 x M / 423 pcs

2.834,⁵⁰ EUR

810.6423

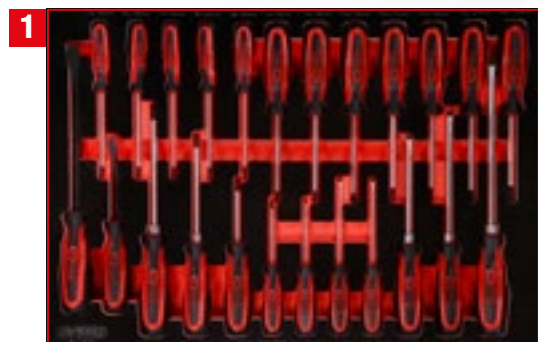

IPCS
24

Screwdriver set in foam insert

811.0024

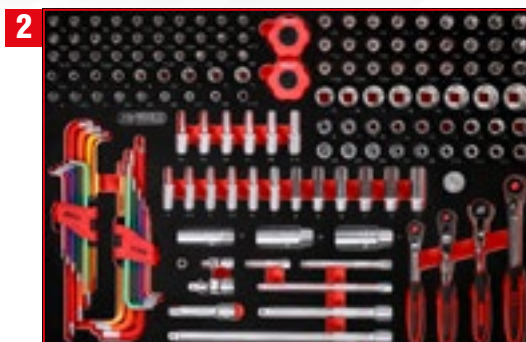

IPCS
156

1/4" + 3/8" socket spanner set in foam insert

811.0156

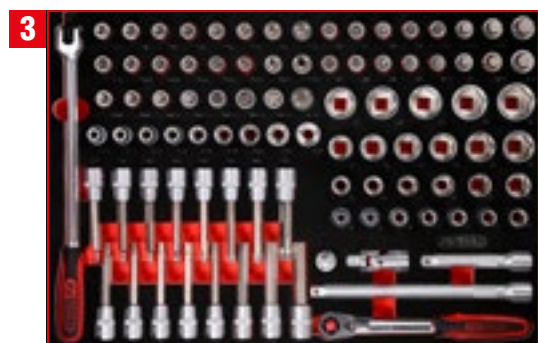

IPCS
95

1/2" socket spanner set in foam insert

811.0095



IPCS
53

Screw spanner set in foam insert

811.0053

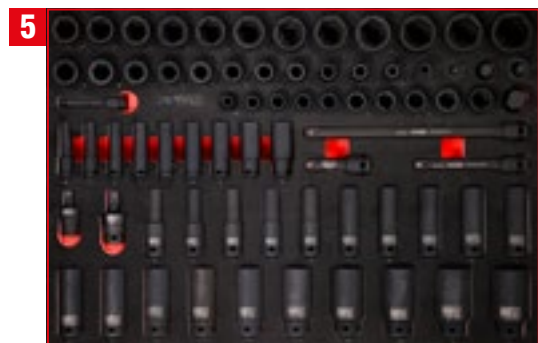

IPCS
73

3/8" + 1/2" socket spanner set in foam insert

811.0073



IPCS
22

Pliers, hammer and chisel set in foam insert

811.2022

P 10

P 15

P 20

P 25

P 30

P 35

P 40

P 45

Individual parts

Accessories

P10 workshop tool trolley set with 397 tools for 7 drawers

810.7397



IPCS
397

M

BUNDLE PRICE!

**7 x M
397 pcs**

2.699,-^{EUR}

810.7397

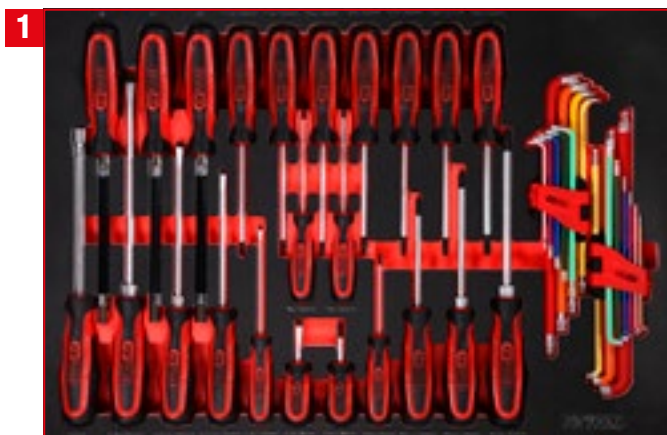

Screw spanner set in foam insert

811.0041

IPCS
41



1/4" + 3/8" + 1/2" socket spanner set in foam insert

811.0111

IPCS
111



3
1/2" screwdriver bit set
in foam insert
811.1111



4
Screw spanner set in foam
insert
811.1041



5
Pliers and file set in
foam insert
811.0019



6
Oil and tyre servicing set
in foam insert
811.0043

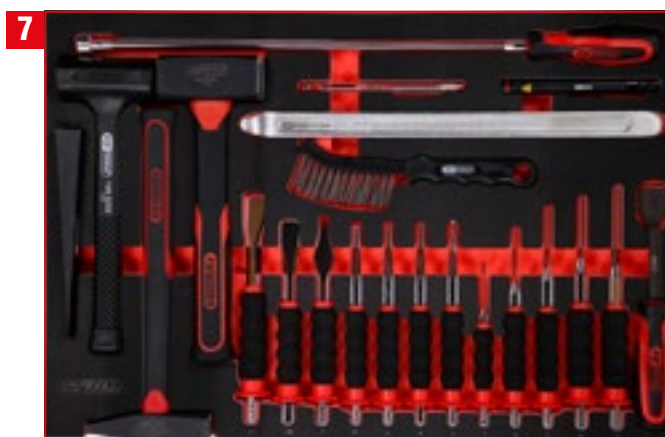

7
Hammer and chisel set
in foam insert
811.0022



P 10

P 15

P 20

P 25

P 30

P 35

P 40

P 45

Individual parts

Accessories

P10 workshop tool trolley set with 399 tools for 7 drawers

810.7399



IPCS
399

M

BUNDLE PRICE!

**7 x M
399 pcs**

2.760,⁵⁰ EUR

810.7399

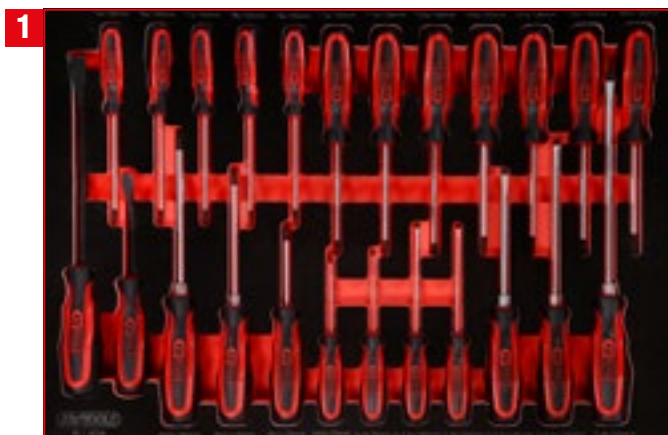

Screwdriver set in foam insert

811.0024

IPCS
24

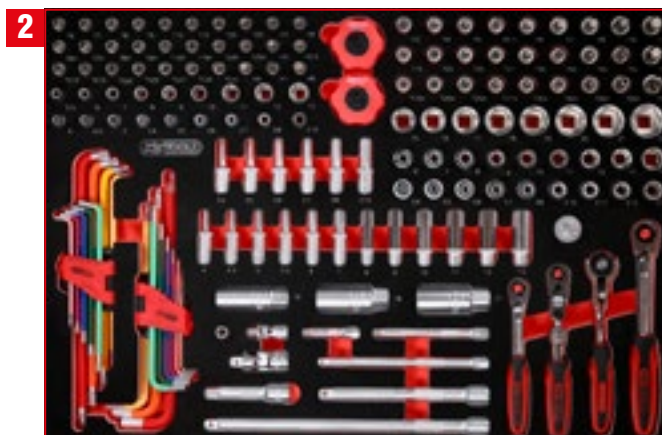

1/4" + 3/8" socket spanner set in foam insert

811.0156

IPCS
156



3
1/2" socket spanner set in foam insert

811.0095

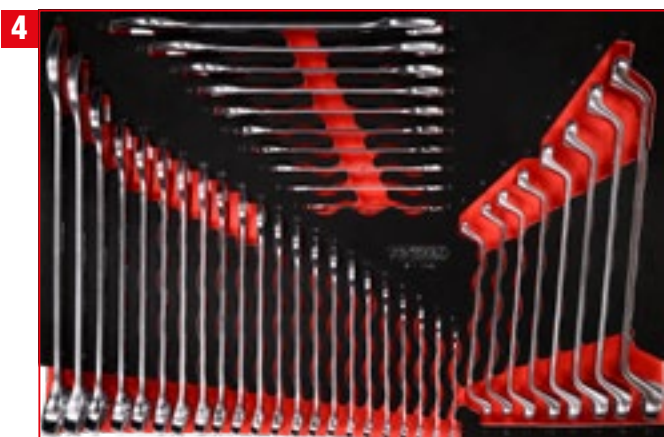

4
Screw spanner set in foam insert

811.1040



5
Screw spanner set in foam insert

811.0051



6
Spanner set in foam insert

811.0012



7
Hammer, chisel and file set in foam insert

811.0021



P 10

P 15

P 20

P 25

P 30

P 35

P 40

P 45

Individual parts

Accessories

P10 workshop tool trolley set with 403 tools for 7 drawers

810.7403



403

M

BUNDLE PRICE!

**7 x M
403 pcs**

2.460,⁹⁰ EUR

810.7403

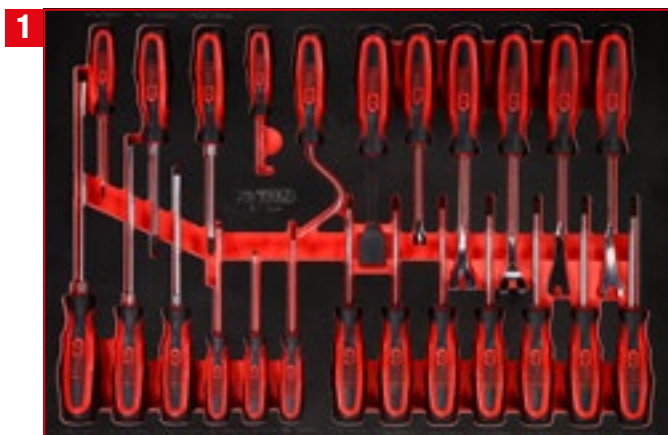

Screwdriver set in
foam insert

811.3024

24

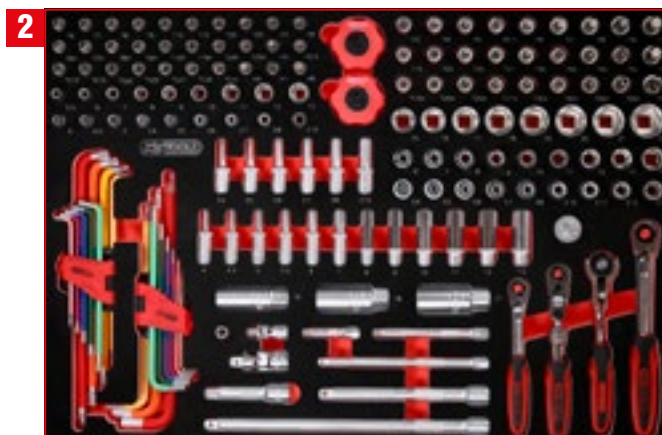

1/4" + 3/8" socket
spanner set in foam insert

811.0156

156



1/2" socket spanner set
in foam insert

811.0066



1/2" socket spanner /
screwdriver bit set

811.0063



Screw spanner set in
foam insert

811.2041



Screwdriver and spanner
set in foam insert

811.1032



Hammer, chisel and
file set in foam insert

811.0021



P10 workshop tool trolley set with 536 tools for 8 drawers

810.8536



536 PCS
536

M

BUNDLE PRICE!

**8 x M
536 pcs**

3.316,⁹⁰_{EUR}

810.8536

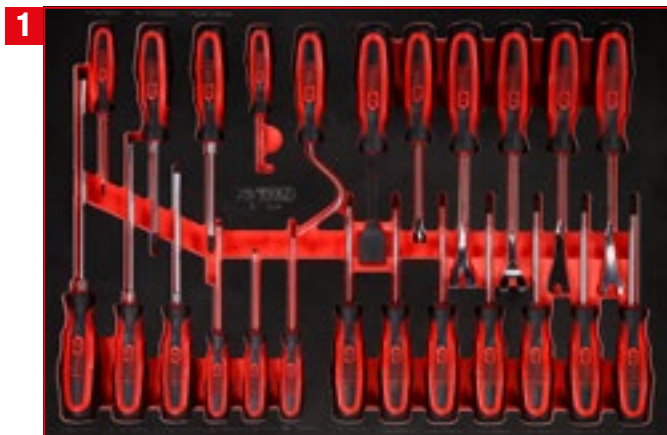

Screwdriver set in foam insert

811.3024

24 PCS
24

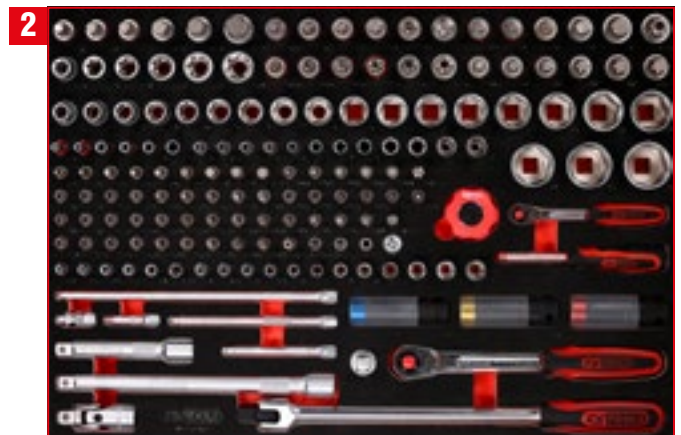

1/4" + 1/2" socket spanner set in foam insert

811.0167

167 PCS
167

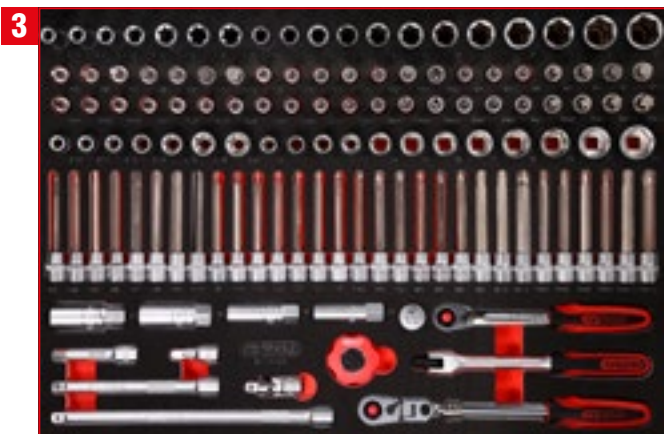

3/8" socket spanner set in foam insert

811.0124

124 PCS



1/2" socket spanner and screwdriver bit set

811.0063

63 PCS



Screw spanner set in foam insert

811.0050

50 PCS

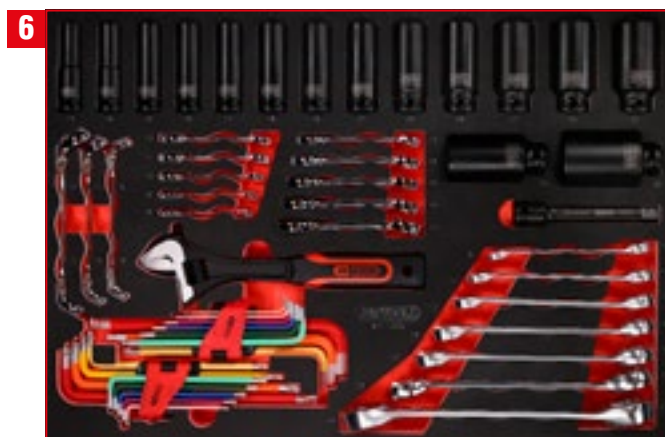

Spanner and impact socket set in foam insert

811.1055

55 PCS



Screwdriver and spanner set in foam insert

811.1032

32 PCS



Hammer, chisel and file set in foam insert

811.0021

21 PCS

P 10

P 15

P 20

P 25

P 30

P 35

P 40

P 45

Individual parts

Accessories

P15 workshop tool trolley set with 241 tools for 4 drawers

815.4241



IPCS
241

M

BUNDLE PRICE!

**4 x M
180 pcs**

1.979,⁵⁰ EUR

815.4281

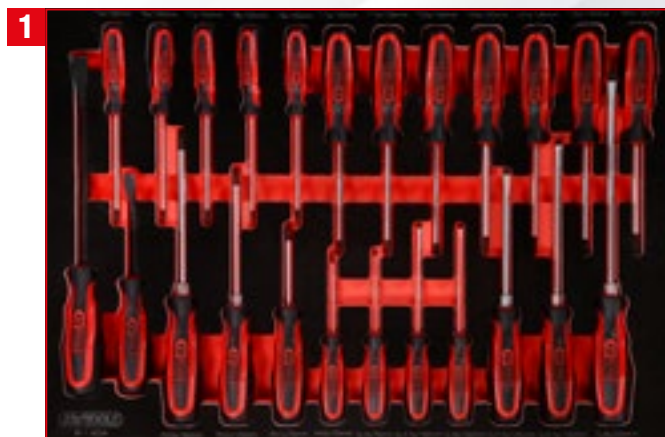

Screwdriver set in foam insert

811.0024

IPCS
24



1/4" + 3/8" + 1/2" socket spanner set in foam insert

811.0159

IPCS
159



Screw spanner set in foam insert

811.1041

IPCS
41



Pliers, hammer and chisel set in foam insert

811.0017

IPCS
17

P15 workshop tool trolley set with 180 tools for 4 drawers

815.4180



180 PCS
180

M

BUNDLE PRICE!

**4 x M
240 pcs**

2.086,50

EUR
815.4180

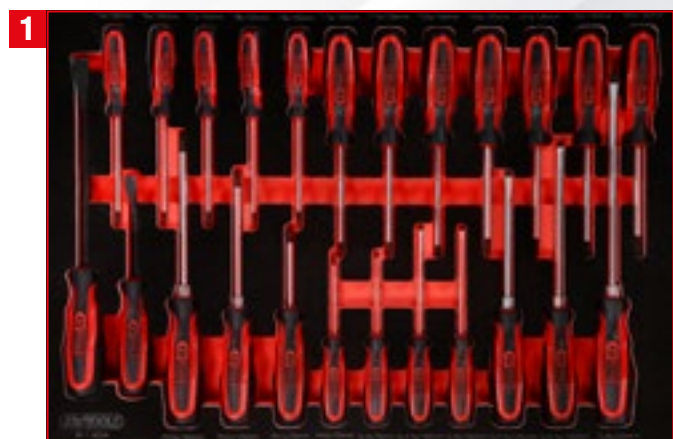

1 Screwdriver set in foam insert

811.0024

24 PCS



2 1/4" + 3/8" + 1/2" socket spanner set in foam insert

811.0092

92 PCS



3 Screw spanner set in foam insert

811.0031

31 PCS



4 Pliers, hammer and chisel set in foam insert

811.0033

33 PCS

P 10

P 15

P 20

P 25

P 30

P 35

P 40

P 45

Individual parts

Accessories

P15 workshop tool trolley set with 262 tools for 5 drawers

815.5262



M

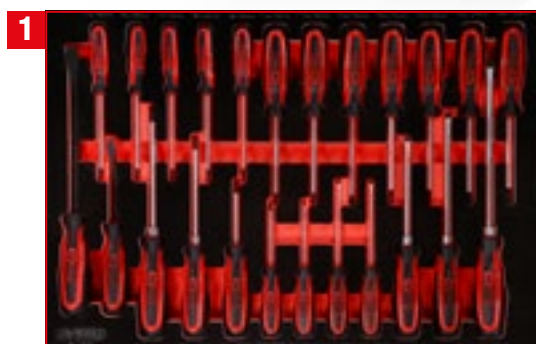

Screwdriver set in foam insert

811.0024



1/4" + 3/8" + 1/2" socket spanner set
in foam insert

811.0159



Screw spanner set in foam insert

811.1040



T-handle and screwdriver set in foam
insert

811.1022



Pliers, hammer and chisel set in foam
insert

811.0017

BUNDLE PRICE!

**5 x M
262 pcs**

2.353,⁹⁰ EUR

815.5262

P15 workshop tool trolley set with 279 tools for 5 drawers

815.5279



M

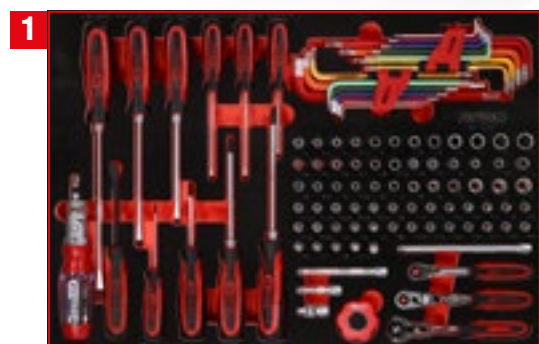

IPCS
105

1/4" socket spanner and screwdriver set in foam insert

811.0105



IPCS
101

3/8" + 1/2" socket spanner set in foam insert

811.0101



IPCS
40

Screw spanner set in foam insert

811.1040



IPCS
12

Spanner set in foam insert

811.0012



IPCS
21

Hammer, chisel and file set in foam insert

811.0021

BUNDLE PRICE!

**5 x M
279 pcs**

2.353,90

815.5279

P15 workshop tool trolley set with 299 tools for 5 drawers

815.5299



M

BUNDLE PRICE!

5 x M / 299 pcs

2.567,90
EUR

815.5299



IPCS
34

Screwdriver set in foam insert

811.0034

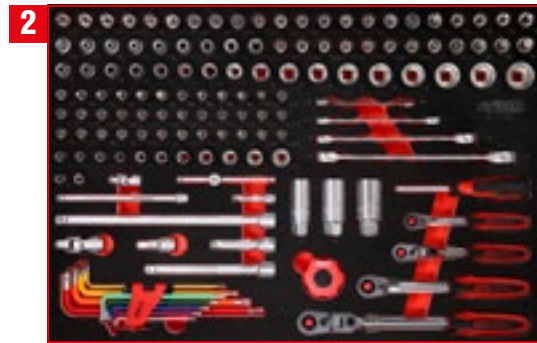

IPCS
140

1/4" + 3/8" socket spanner set in foam insert

811.0140



IPCS
64

1/2" screwdriver bit set in foam insert

811.0064



ITLG
38

Screw spanner set in foam insert

811.0038



IPCS
23

Pliers, hammer and chisel set in foam insert

811.1023

P15 workshop tool trolley set with 271 tools for 6 drawers

815.6271



M

BUNDLE PRICE!

6 x M / 271 pcs

2.653,50 EUR

815.6271

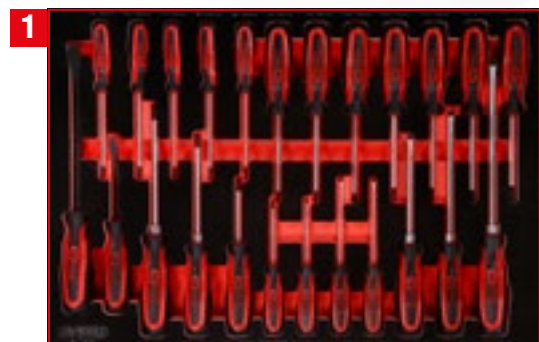

Screwdriver set in foam insert

811.0024



1/4" + 3/8" + 1/2" socket spanner set in foam insert

811.0139



Screw spanner set in foam insert

811.0053

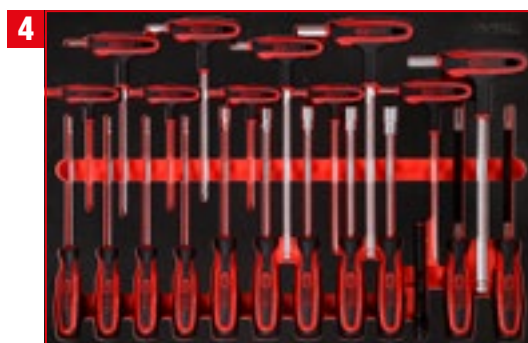

T-handle and screwdriver set in foam insert

811.1022



Spanner set in foam insert

811.0012



Hammer, chisel and file set in foam insert

811.0021

P15 workshop tool trolley set with 284 tools for 6 drawers

815.6284



M

BUNDLE PRICE!

6 x M / 284 pcs

2.771,50

815.6284

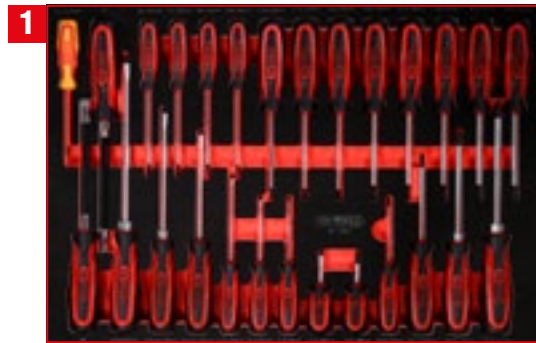

Screwdriver set in foam insert

811.0027

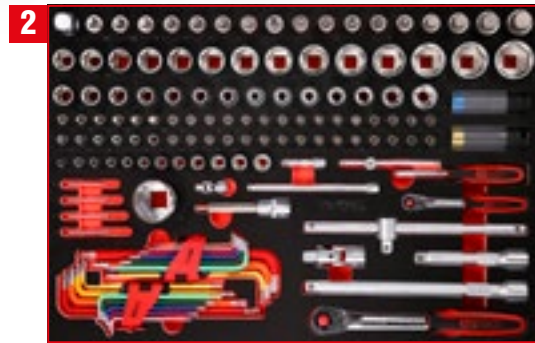

1/4" + 1/2" socket spanner set in foam insert

811.1137

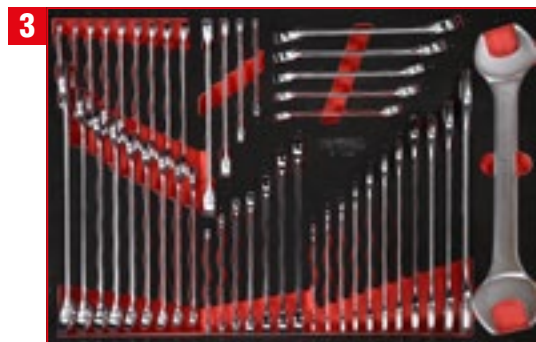

Screw spanner set in foam insert

811.0046



Screw spanner set in foam insert

811.1024



Pliers and file set in foam insert

811.0019



Hammer and chisel set in foam insert

811.0022

P15 workshop tool trolley set with 338 tools for 6 drawers

815.6338



M

BUNDLE PRICE!

6 x M / 338 pcs

2.674,90

815.6338



Screwdriver set in foam insert

811.1027



1/4" + 3/8" socket spanner set in foam insert

811.1142



1/2" socket spanner set in foam insert

811.0066



Screw spanner set in foam insert

811.2041



Pliers and angle spanner set in foam insert

811.0045



Hammer and chisel set in foam insert

811.1017

P15 workshop tool trolley set with 366 tools for 6 drawers

815.6366



M

BUNDLE PRICE!

6 x M / 366 pcs

2.674,90
EUR

815.6366



1

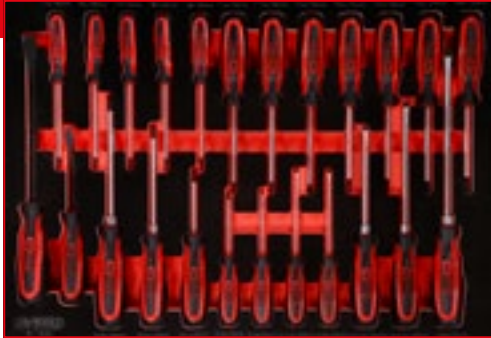

Screwdriver set in foam insert

811.0024

2

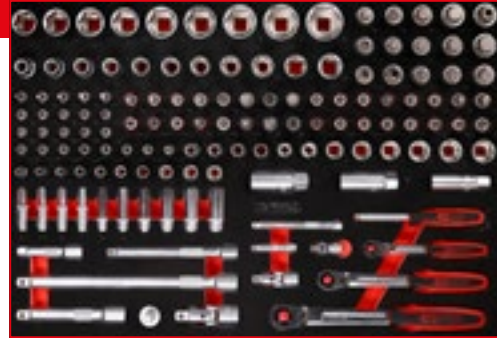

1/4" + 3/8" + 1/2" socket
spanner set in foam insert

811.0139

3

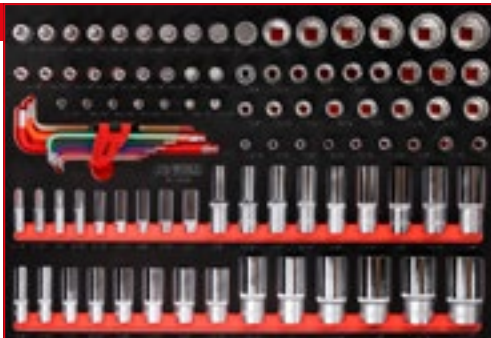

1/4" + 3/8" + 1/2" socket
spanner set in foam insert

811.0099

4



Screw spanner set in foam insert

811.1040

5



Screw spanner set in foam insert

811.0031

6



Pliers, hammer and chisel
set in foam insert

811.0033

P15 workshop tool trolley set with 370 tools for 6 drawers

815.6370



M

BUNDLE PRICE!

6 x M / 370 pcs

2.995,90 EUR

815.6370

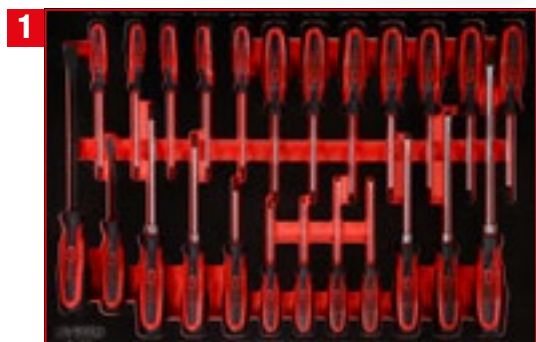

IPCS
24

Screwdriver set in foam insert

811.0024



IPCS
148

1/4" + 3/8" socket spanner set in foam insert

811.0148



IPCS
95

1/2" socket spanner set in foam insert

811.1095



IPCS
53

Screw spanner set in foam insert

811.0053



IPCS
19

Pliers and file set in foam insert

811.0019



IPCS
22

Hammer and chisel set in foam insert

811.0022

P15 workshop tool trolley set with 399 tools for 6 drawers

815.6399



M

BUNDLE PRICE!

6 x M / 399 pcs

2.771,50
EUR

815.6399

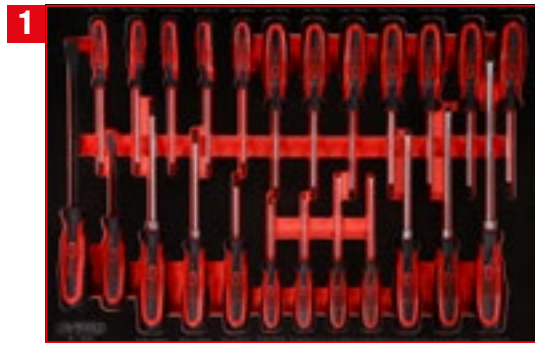

1

IPCS
24

Screwdriver set in foam insert

811.0024

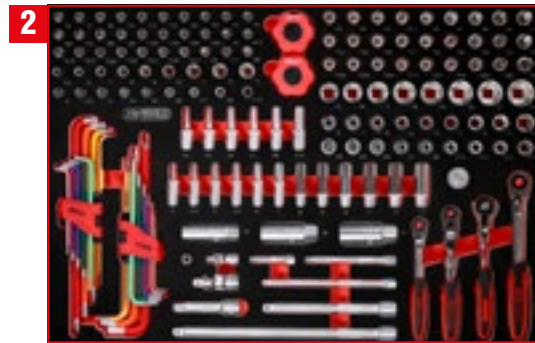

2

IPCS
156

1/4" + 3/8" socket spanner set in foam insert

811.0156

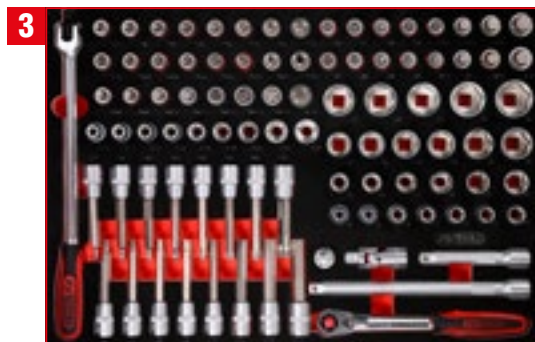

3

IPCS
95

1/2" socket spanner set in foam insert

811.0095



4

IPCS
40

Screw spanner set in foam insert

811.1040



5

IPCS
51

Screw spanner set in foam insert

811.0051



6

IPCS
33

Pliers, hammer and chisel set in foam insert

811.0033

P15 workshop tool trolley set with 423 tools for 6 drawers

815.6423



M

BUNDLE PRICE!

6 x M / 423 pcs

2.995,90 EUR

815.6423

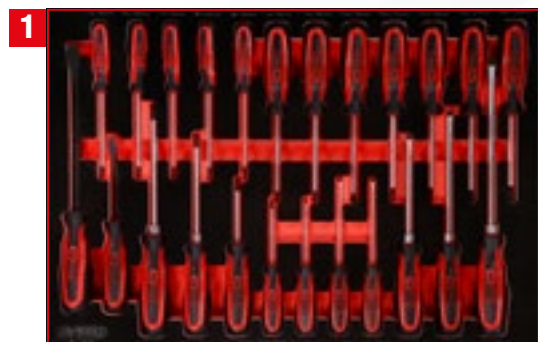

IPCS
24

Screwdriver set in foam insert

811.0024

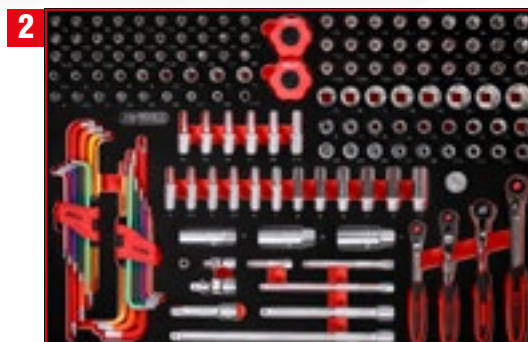

IPCS
156

1/4" + 3/8" socket spanner set in foam insert

811.0156

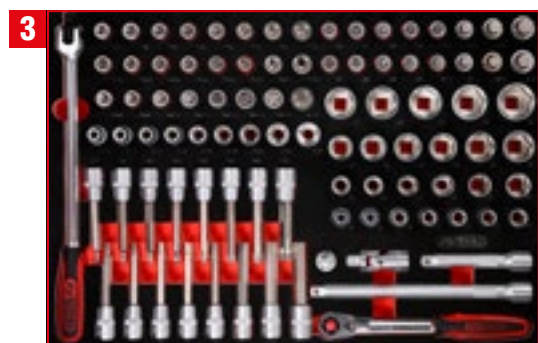

IPCS
95

1/2" socket spanner set in foam insert

811.0095



IPCS
53

Screw spanner set in foam insert

811.0053

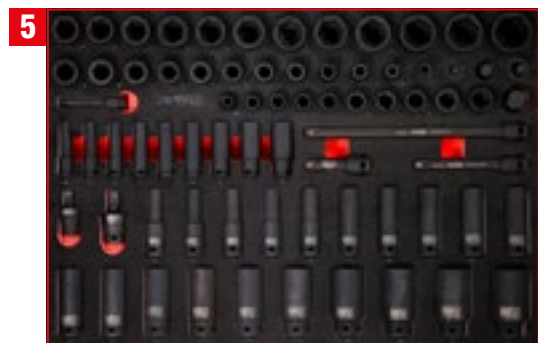

IPCS
73

3/8" + 1/2" socket spanner set in foam insert

811.0073



IPCS
22

Pliers, hammer and chisel set in foam insert

811.2022

P15 workshop tool trolley set with 397 tools for 7 drawers

815.7397

PCS
397

M

BUNDLE PRICE!

**7 x M
397 pcs**

2.799, ^{EUR}

815.7397

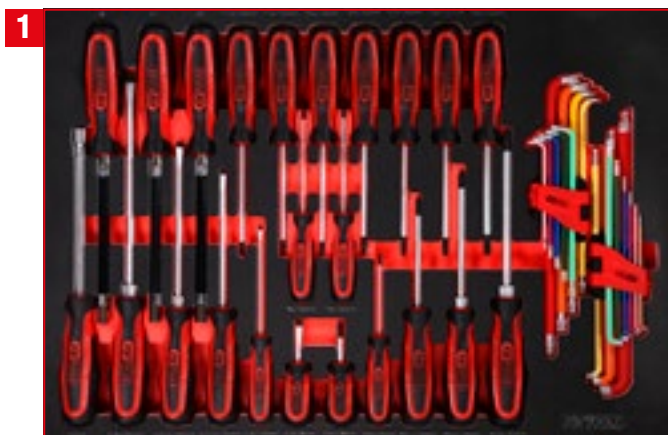

Screw spanner set in foam insert

811.0041

PCS
41



1/4" + 3/8" + 1/2" socket spanner set in foam insert

811.0111

PCS
111



1/2" screwdriver bit set
in foam insert

811.1111



Screw spanner set in
foam insert

811.1041



Pliers and file set in foam
insert

811.0019



Oil and tyre servicing set
in foam insert

811.0043



Hammer and chisel set in
foam insert

811.0022



P 10

P 15

P 20

P 25

P 30

P 35

P 40

P 45

Individual parts

Accessories

P15 workshop tool trolley set with 399 tools for 7 drawers

815.7399

PCS
399

M

BUNDLE PRICE!

7 x M
399 pcs

2.942,⁵⁰ EUR

815.7399

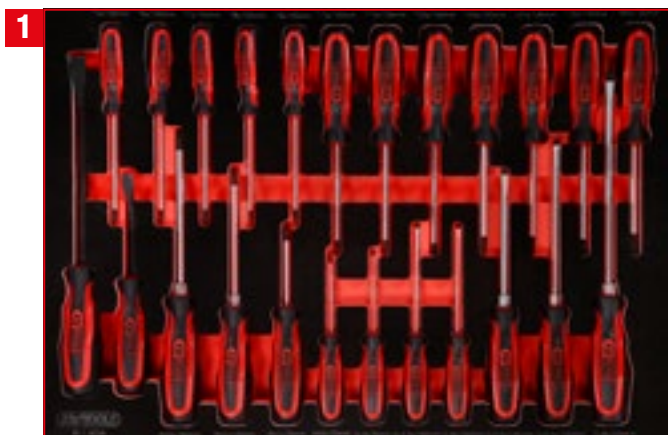

Screwdriver set in foam insert

811.0024

PCS
24

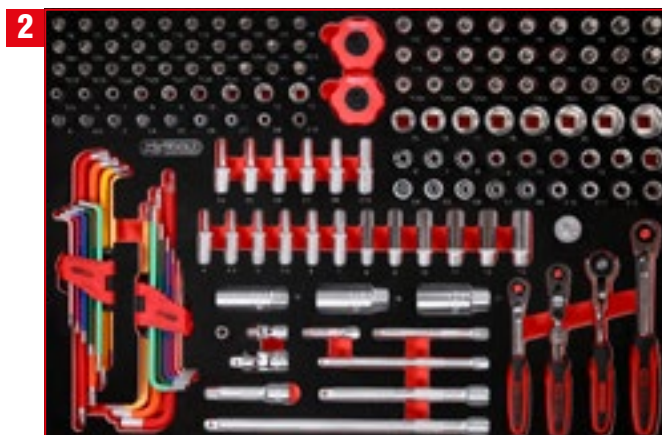

1/4" + 3/8" socket spanner set in foam insert

811.0156

PCS
156

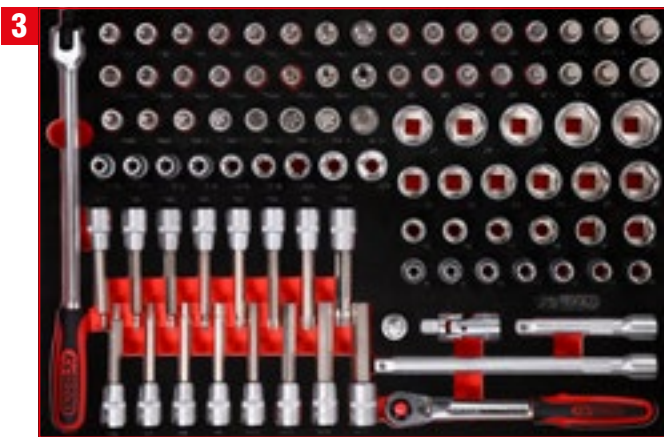

3
1/2" socket spanner set in foam insert

811.0095

95



4
Screw spanner set in foam insert

811.1040

40



5
Screw spanner set in foam insert

811.0051

51



6
Spanner set in foam insert

811.0012

12



7
Hammer, chisel and file set in foam insert

811.0021

21

P 10

P 15

P 20

P 25

P 30

P 35

P 40

P 45

Individual parts

Accessories

P15 workshop tool trolley set with 403 tools for 7 drawers

815.7403

403

M

BUNDLE PRICE!

7 x M
403 pcs

2.653,⁵⁰ EUR

815.7403

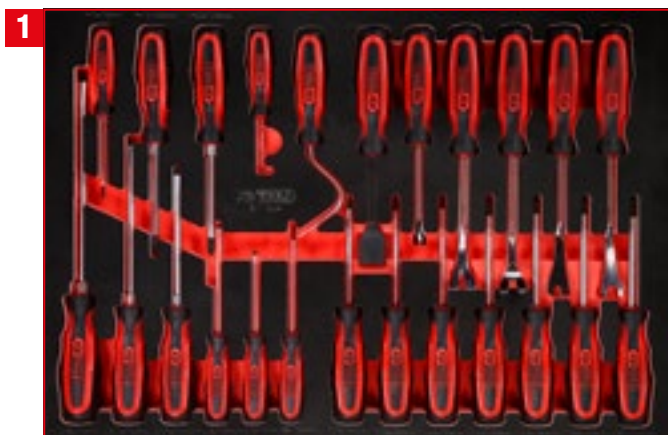

Screwdriver set in foam insert

811.3024

24

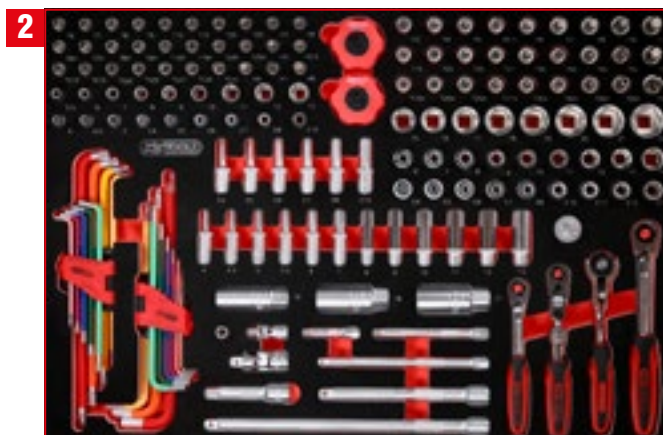

1/4" + 3/8" socket spanner set in foam insert

811.0156

156



1/2" socket spanner set in foam insert

811.0066



1/2" socket spanner and screwdriver bit set

811.0063



Screw spanner set in foam insert

811.2041



Screwdriver and spanner set in foam insert

811.1032



Hammer, chisel and file set in foam insert

811.0021



P 10

P 15

P 20

P 25

P 30

P 35

P 40

P 45

Individual parts

Accessories

P15 workshop tool trolley set with 536 tools for 8 drawers

815.8536

1 PCS
536

M

BUNDLE PRICE!

**8 x M
536 pcs**

3.563,⁵⁰ EUR

815.8536

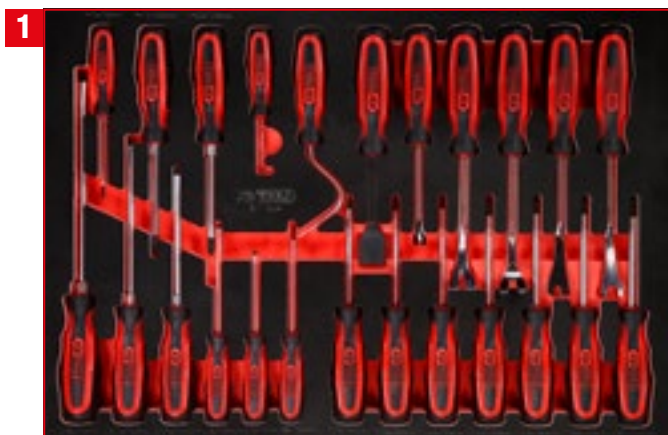

Screwdriver set in foam insert

811.3024

1 PCS
24

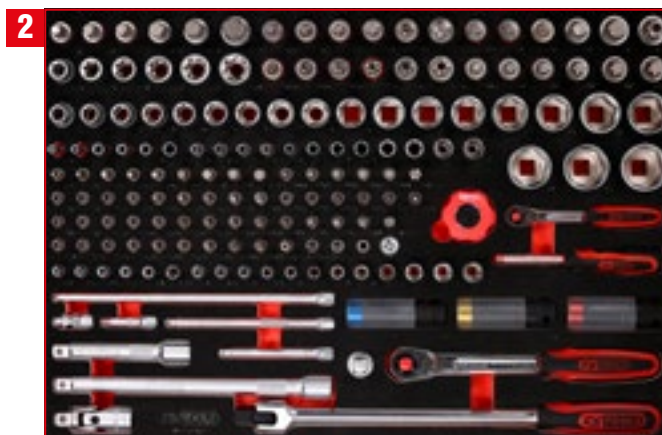

1/4" + 1/2" socket spanner set in foam insert

811.0167

1 PCS
167

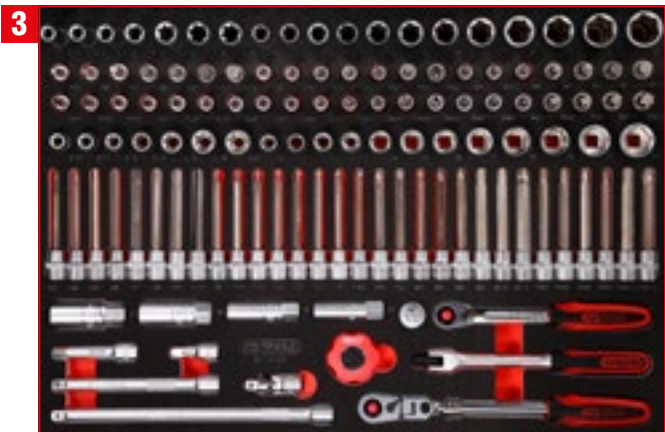

3/8" socket spanner set in foam insert

811.0124

124 PCS



1/2" socket spanner and screwdriver bit set

811.0063

63 PCS



Screw spanner set in foam insert

811.0050

50 PCS



Spanner and impact socket set in foam insert

811.1055

55 PCS



Screwdriver and spanner set in foam insert

811.1032

32 PCS



Hammer, chisel and file set in foam insert

811.0021

21 PCS

P 10

P 15

P 20

P 25

P 30

P 35

P 40

P 45

Individual parts

Accessories

P20 workshop tool trolley set with 706 tools for 7 drawers

820.9706



IPCS
706

M

5 6 8 9

XL

1 2 3 4 7

BUNDLE PRICE!

**4 x M, 5 x XL
706 pcs**

5.349,⁹⁰

820.9706

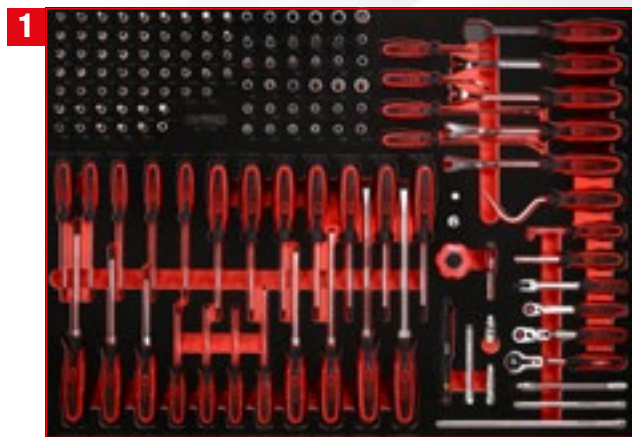

1/4" socket spanner and
screwdriver set

821.0142

IPCS
142

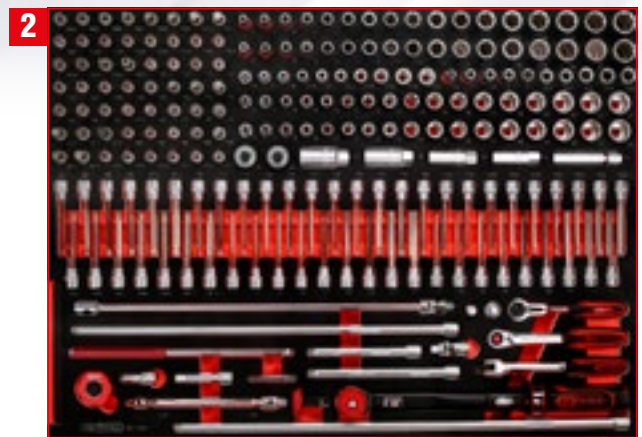

3/8" socket spanner set
in foam insert

821.0221

IPCS
221



1/2" socket spanner set
in foam insert

821.0149

IPCS
149



Screw spanner set in
foam insert

821.0076

IPCS
76

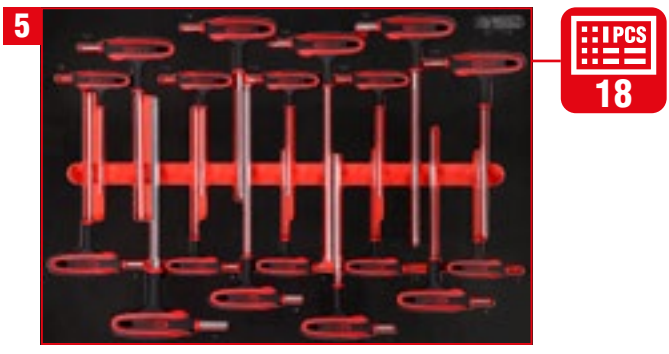

T-handle angle spanner set in foam insert

811.1018



T-handle angle spanner set in foam insert

811.2018



Spanner set in foam insert

821.0034



Hammer and chisel set in foam insert

811.0020



Measuring tool and file set in foam insert

811.0028

P 10

P 15

P 20

P 25

P 30

P 35

P 40

P 45

Individual parts

Accessories

P25 workshop tool trolley set with 285 tools for 4 drawers

825.4285



IPCS
285

L

BUNDLE PRICE!

**4 x L
285 pcs**

2.653,⁵⁰ EUR
825.4285



1

IPCS
30

Pliers and measuring tool set in foam insert

813.0030



2

IPCS
156

1/4" + 3/8" + 1/2" socket spanner set in foam insert

813.0156

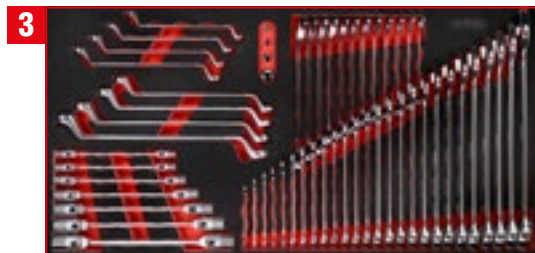

3

IPCS
57

Screw spanner set in foam insert

813.0057

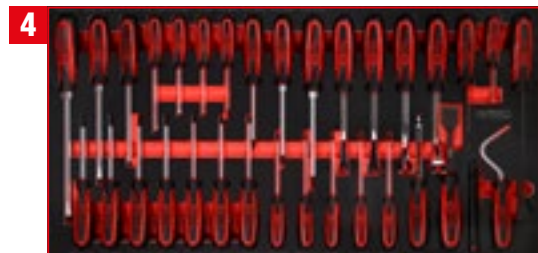

4

IPCS
33

Screwdriver set in foam insert

813.0033

P25 workshop tool trolley set with 416 tools for 6 drawers

825.6416



BUNDLE PRICE!

6 x L / 416 pcs

3.637,90 EUR

825.6416



Screwdriver set in foam insert

813.1033

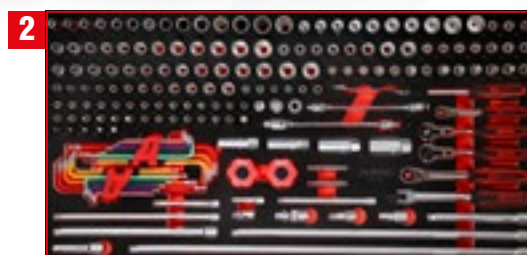

1/4" + 3/8" socket spanner set in foam insert

813.0183



1/2" socket spanner set in foam insert

813.0085

44

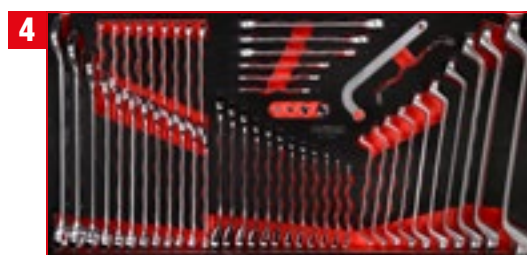

Screw spanner set in foam insert

813.0055



T-handle angle wrench and screwdriver set in foam insert

813.0024



Hammer, chisel and measuring tool set in foam insert

813.1036

P25 workshop tool trolley set with 446 tools for 6 drawers

825.6446



BUNDLE PRICE!

6 x L / 446 pcs

3.530,⁹⁰ EUR

825.6446



Screwdriver set in foam insert

813.1033

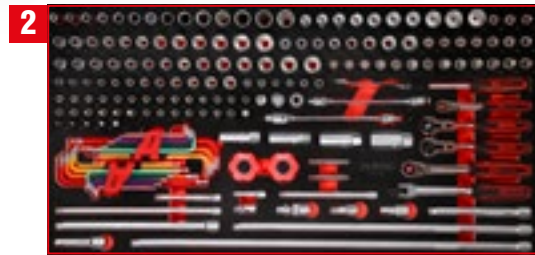

1/4" + 3/8" socket spanner set in foam insert

813.0183



1/2" socket spanner set in foam insert

813.0117

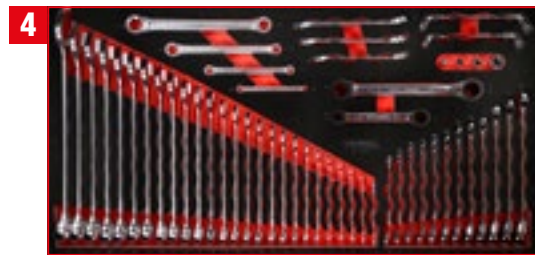

Screw spanner set in foam insert

813.0053



T-handle angle wrench and screwdriver set in foam insert

813.0024



Hammer, chisel and measuring tool set in foam insert

813.1036



P 10

P 15

P 20

P 25

P 30

P 35

P 40

P 45

Individual parts

Accessories

P25 workshop tool trolley set with 510 tools for 7 drawers

825.7510



510 PCS
510

L

BUNDLE PRICE!

**7 x L
510 pcs**

3.851,90 EUR

825.7510

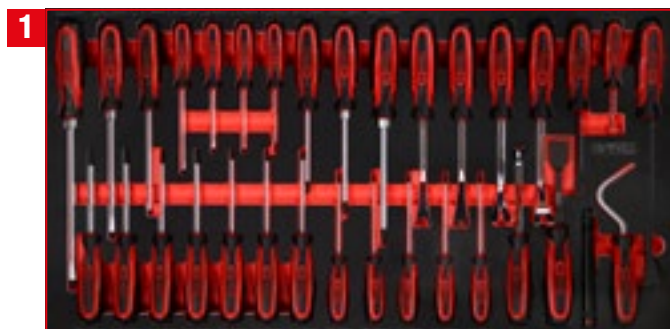

Screwdriver set in foam
insert

813.0033

33 PCS



1/4" + 3/8" socket spanner
set in foam insert

813.0213

213 PCS



3
1/2" socket spanner set in foam insert

813.0086

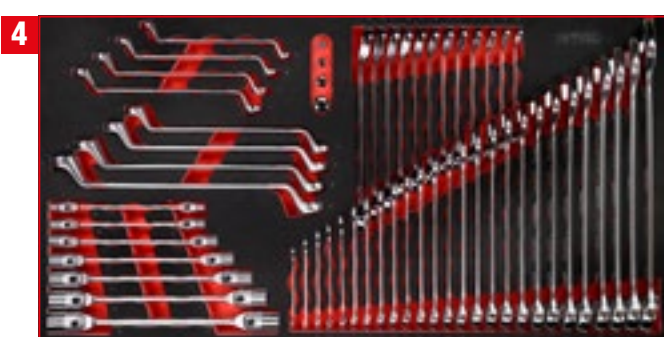

4
Screw spanner set in foam insert

813.0057

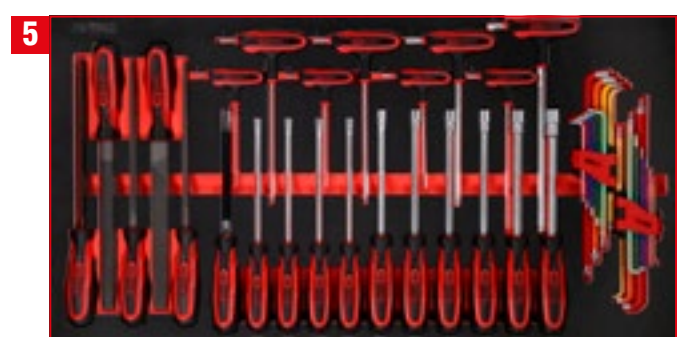

5
Screwdriver and file set in foam insert

813.0042

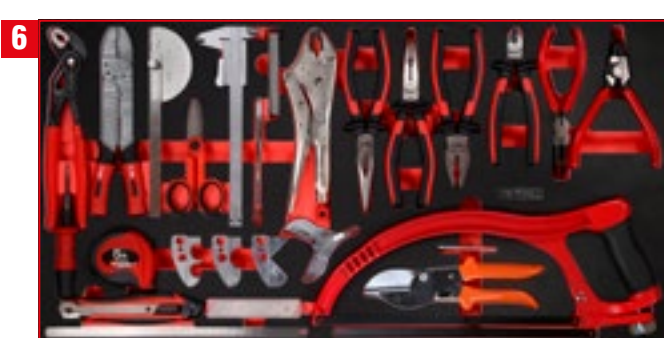

6
Pliers and measuring tool set in foam insert

813.0030

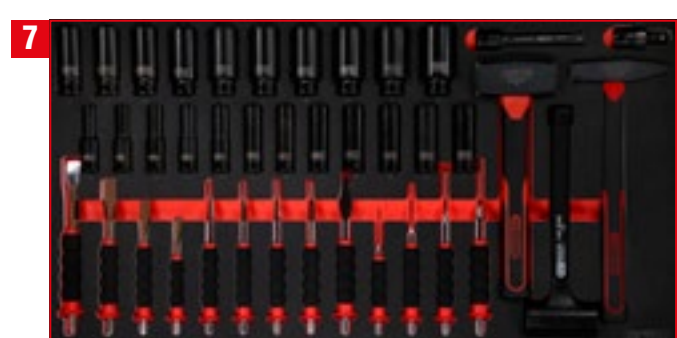

7
Hammer, chisel and impact socket set in foam insert

813.0040

P25 workshop tool trolley set with 564 tools for 8 drawers

825.8564



564

L

BUNDLE PRICE!

**8 x L
564 pcs**

3.799, ^{EUR}

825.8564

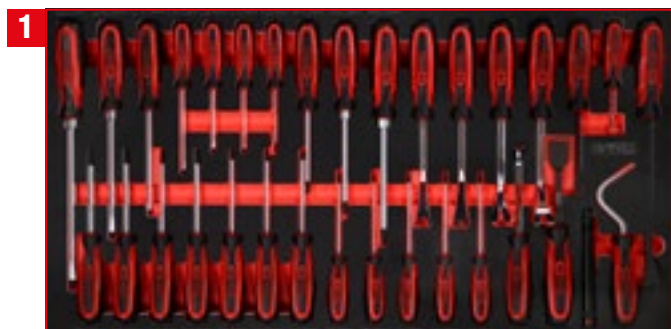

Screwdriver set in foam
insert

813.0033

33



1/4" + 3/8" socket spanner
set in foam insert

813.0213

213



3 1/2" socket spanner set in foam insert

813.0086

PCS
86

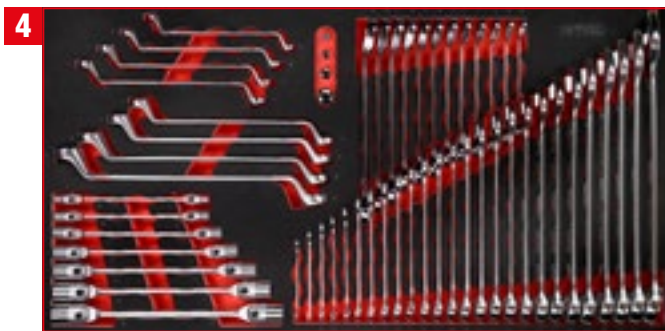

4 Screw spanner set in foam insert

813.0057

PCS
57



5 Screw spanner set in foam insert

813.0054

PCS
54



6 Screwdriver and file set in foam insert

813.0042

PCS
42

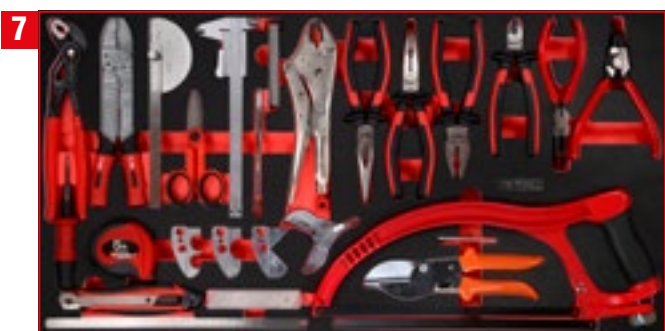

7 Pliers and measuring tool set in foam insert

813.0030

PCS
30



8 Hammer, chisel and impact socket set in foam insert

813.0040

PCS
40

P25 workshop tool trolley set with 660 tools for 8 drawers

825.8660



IPCS
660

L

BUNDLE PRICE!

**8 x L
660 pcs**

4.600,⁹⁰ EUR

825.8660



Screw spanner set in
foam insert

813.0057

IPCS
57

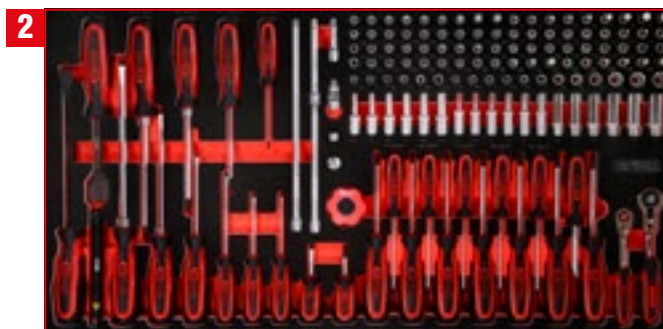

1/4" socket spanner and
screwdriver set

813.0146

IPCS
146



3/8" socket spanner set in foam insert

813.0165

165 PCS



1/2" socket spanner set in foam insert

813.0120

120 PCS

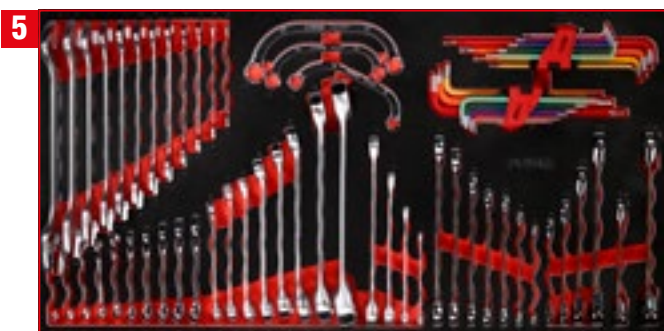

Screw spanner set in foam insert

813.0068

68 PCS

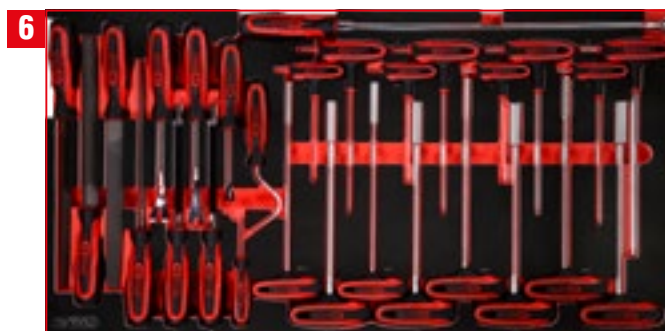

T-handle angle spanner and file set in foam insert

813.0028

28 PCS



Pliers and measuring tool set in foam insert

813.0036

36 PCS



Hammer, chisel and impact socket set in foam insert

813.0040

40 PCS

P 10

P 15

P 20

P 25

P 30

P 35

P 40

P 45

Individual parts

Accessories

P30 workshop tool trolley set with 706 tools for 7 drawers

830.9706

IPCS
706

M

5 6 8 9

XL

1 2 3 4 7



BUNDLE PRICE!

**4 x M, 5 x XL
706 pcs**

**5.670,⁹⁰
EUR**
830.9706

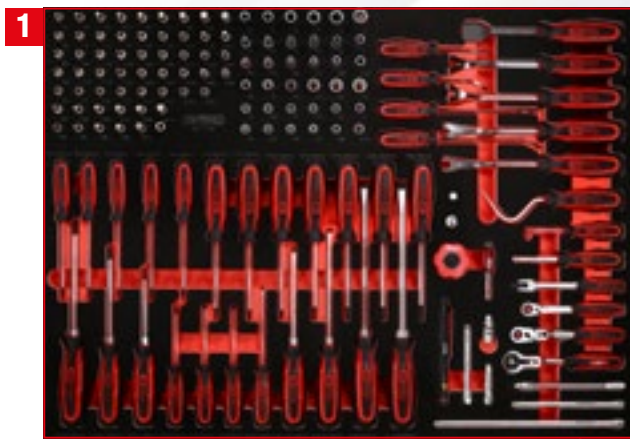

1/4" socket spanner and
screwdriver set

821.0142

IPCS
142

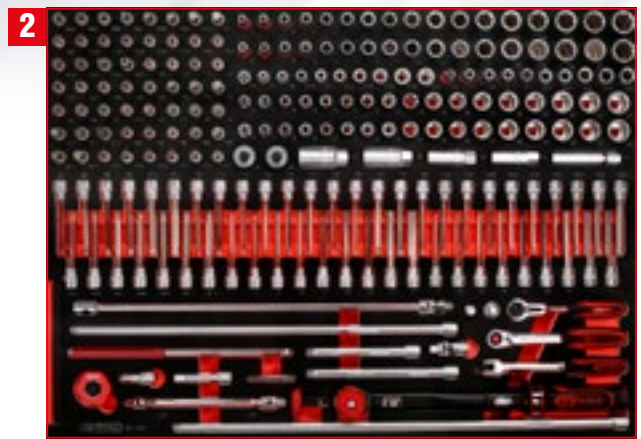

3/8" socket spanner set
in foam insert

821.0221

IPCS
221



1/2" socket spanner set
in foam insert

821.0149

IPCS
149



Screw spanner set in
foam insert

821.0076

IPCS
76

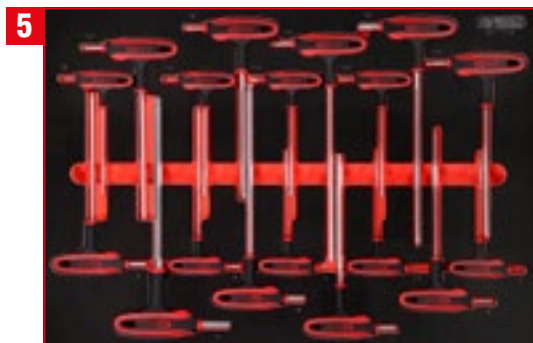

IPCS
18

T-handle angle spanner set in foam insert

811.1018



IPCS
18

T-handle angle spanner set in foam insert

811.2018



IPCS
34

Spanner set in foam insert

821.0034



IPCS
20

Hammer and chisel set in foam insert

811.0020

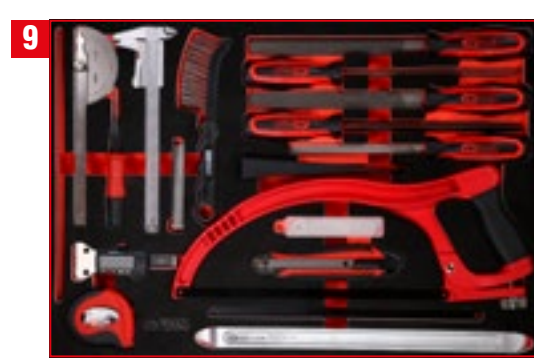

IPCS
28

Measuring tool and file set in foam insert

811.0028

P35 workshop tool trolley set with 279 tools for 5 drawers

835.5279



M

BUNDLE PRICE!

5 x M / 279 pcs

3.445,⁵⁰_{EUR}

835.5279

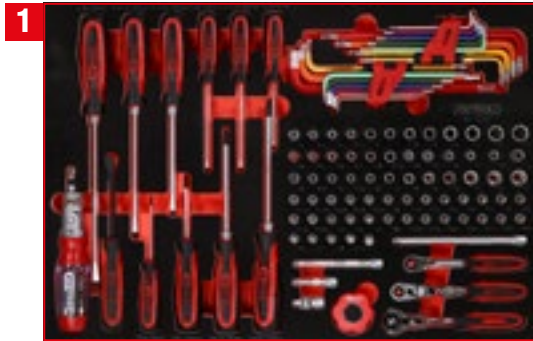

1/4" socket spanner and screwdriver set in foam insert

811.0105



3/8" + 1/2" socket spanner set in foam insert

811.0101



Screw spanner set in foam insert

811.1040



Spanner set in foam insert

811.0012



Hammer, chisel and file set in foam insert

811.0021



P 10

P 15

P 20

P 25

P 30

P 35

P 40

P 45

Individual parts

Accessories

P35 workshop tool trolley set

with 549 tools for 12 drawers

835.12549



BUNDLE PRICE!

10 x M, 2 x S
549 pcs

5.542,⁵⁰ EUR
835.12549



M

1 2 3 4 5
6 7 10 11 12

S

8 9

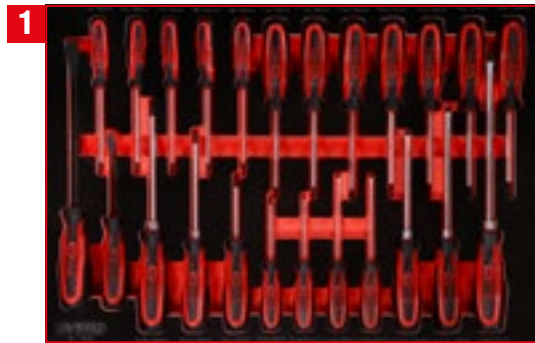

IPCS
24

Screwdriver set in foam insert

811.0024

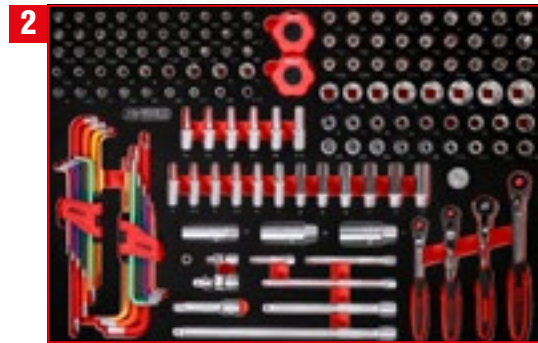

IPCS
156

1/4" + 3/8" socket spanner set in foam insert

811.0156

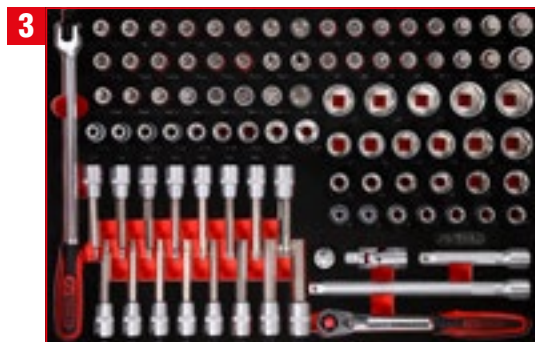

IPCS
95

1/2" socket spanner set in foam insert

811.0095



IPCS
30

Combination spanner set in foam insert

811.0030



IPCS
51

Screw spanner set in foam insert

811.0051

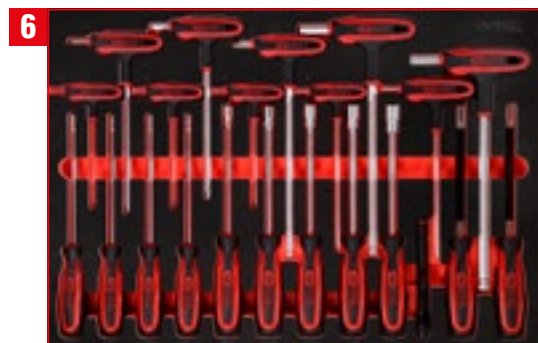

IPCS
22

T-handle and screwdriver set in foam insert

811.1022



Hammer, chisel and file set in foam insert

811.0021



Spanner set in foam insert

811.0007



Spanner set in foam insert

812.0005



3/8" + 1/2" socket spanner set in foam insert

811.0073



3/4" socket spanner set in foam insert

811.0032



3/4" impact socket set in foam insert

811.1033

P 10

P 15

P 20

P 25

P 30

P 35

P 40

P 45

Individual parts

Accessories

P45 workshop tool trolley set

with 706 tools for 7 drawers

845.9706

706

M

6 7 8 9

XL

1 2 3 4 5



BUNDLE PRICE!

**4 x M, 5 x XL
706 pcs**

7.489,⁹⁰ EUR

845.9706

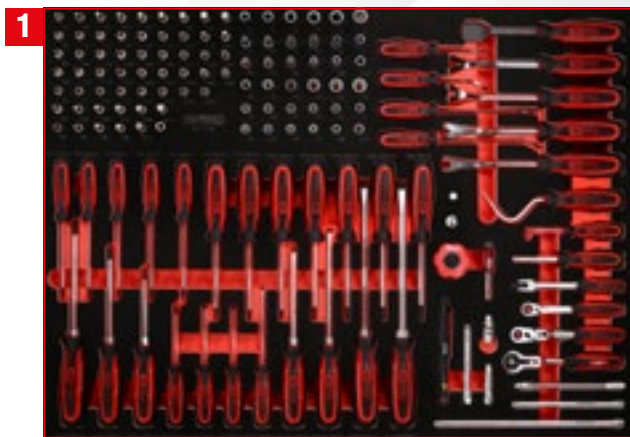

1/4" socket spanner and
screwdriver set

821.0142

142

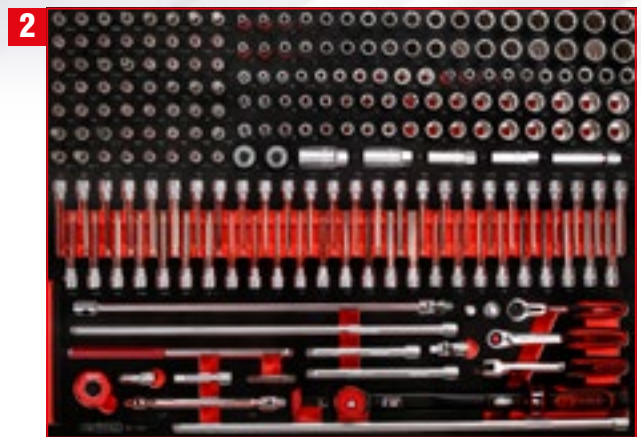

3/8" socket spanner set
in foam insert

821.0221

221



1/2" socket spanner set
in foam insert

821.0149

149



Screw spanner set in
foam insert

821.0076

76



5

Spanner set in foam insert

821.0034

IPCS
34

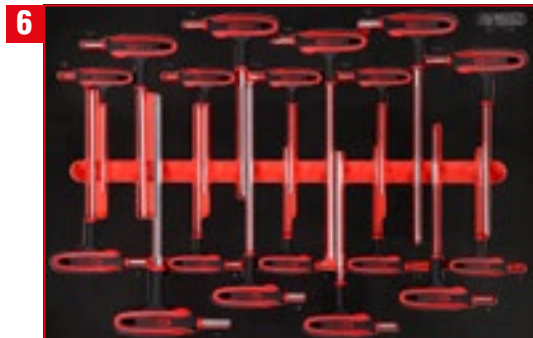

6

T-handle angle spanner set in foam insert

811.1018

IPCS
18



7

T-handle angle spanner set in foam insert

811.2018

IPCS
18



8

Measuring tool and file set in foam insert

811.0028

IPCS
28



9

Hammer and chisel set in foam insert

811.0020

IPCS
20

P 10

P 15

P 20

P 25

P 30

P 35

P 40

P 45

Individual parts

Accessories

P45 workshop tool trolley set with 950 tools for 13 drawers [1 | 2]

845.14950



PCS
950

XL

1 2 3 4 5

M

6 7 8 9 10 11 12 13 14

BUNDLE PRICE!

**5 x XL, 9 x M
950 pcs**

8.773,⁹⁰ EUR

845.14950

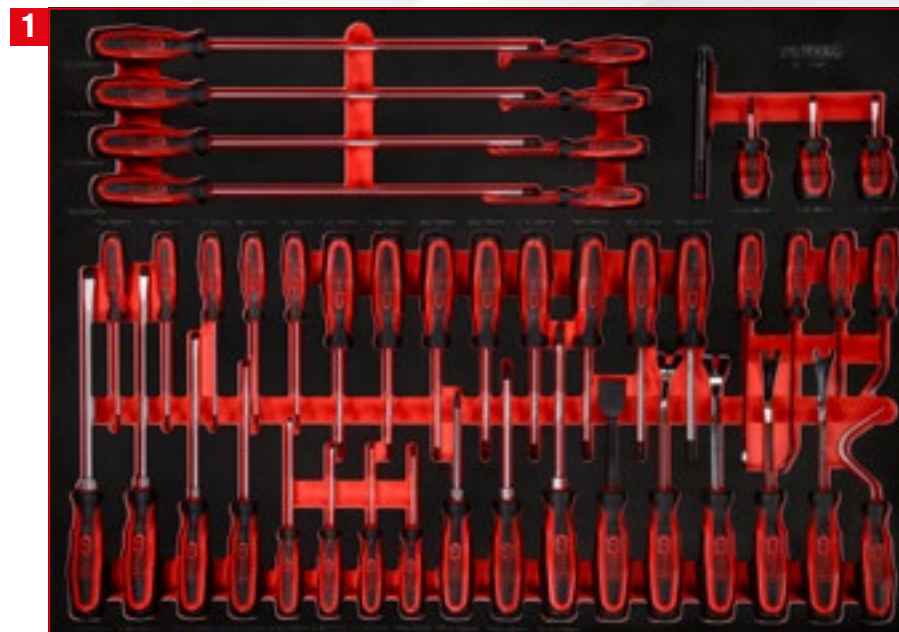

PCS
46

Screwdriver set in foam insert

821.0046

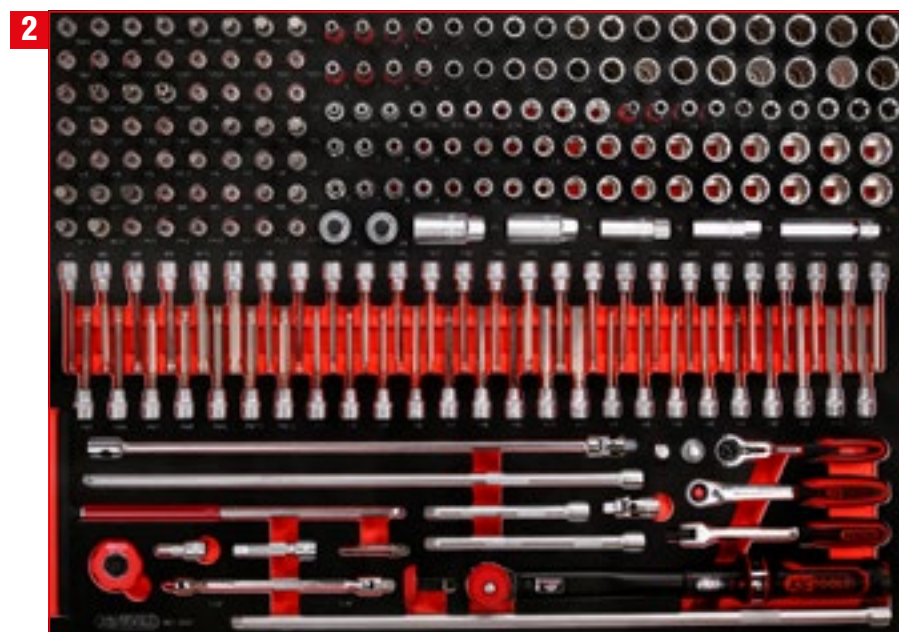

PCS
221

3/8" socket spanner set in foam insert

821.0221



149 PCS

1/2" socket spanner set in foam insert

821.0149



76 PCS

Screw spanner set in foam insert

821.0076



34 PCS

Spanner set in foam insert

821.0034

P 10

P 15

P 20

P 25

P 30

P 35

P 40

P 45

Individual parts

Accessories

P45 workshop tool trolley set with 950 tools for 13 drawers [2 | 2]

845.14950



950

XL

1 2 3 4 5

M

6 7 8 9 10 11 12 13 14

BUNDLE PRICE!

**5 x XL, 9 x M
950 pcs**

8.773,⁹⁰ EUR

845.14950



6

1/2" impact socket set in foam insert

811.0039

39



7

Screwdriver and hook set in foam insert

811.1019

19



8

Hammer and chisel set in foam insert

811.0020

20



9

1/4" socket spanner set in foam insert

811.0169

169



10 1/2" screwdriver bit set in foam insert

811.1064



11 Screw spanner set in foam insert

811.0049

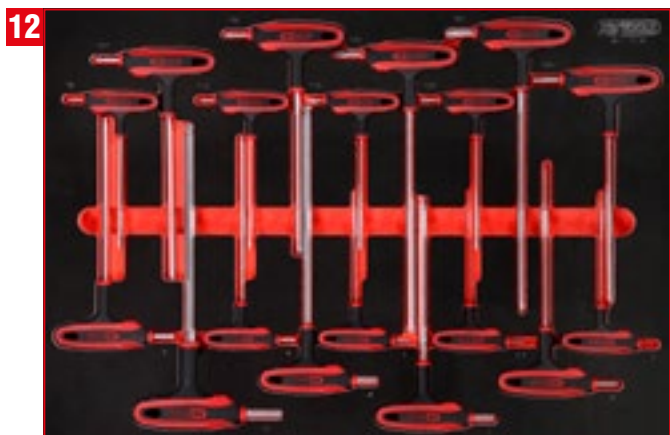

12 T-handle angle spanner set in foam insert

811.1018



13 T-handle angle spanner set in foam insert

811.2018



14 Measuring tool and file set in foam insert

811.0028



P 10

P 15

P 20

P 25

P 30

P 35

P 40

P 45

Individual parts

Accessories

For the Performance Plus workshop trolleys to work, hundreds of individual parts need to work together in harmony.

In order to ensure that your workshop trolley is just as reliable in many years as it is on the day you got it, we guarantee you that every component is interchangeable.

MORE THAN THE SUM OF ITS PARTS



AFTERSALES WARRANTY ON ALL PARTS

Easy exchange

QUICK AVAILABILITY FOR CONTINUOUS PERFORMANCE

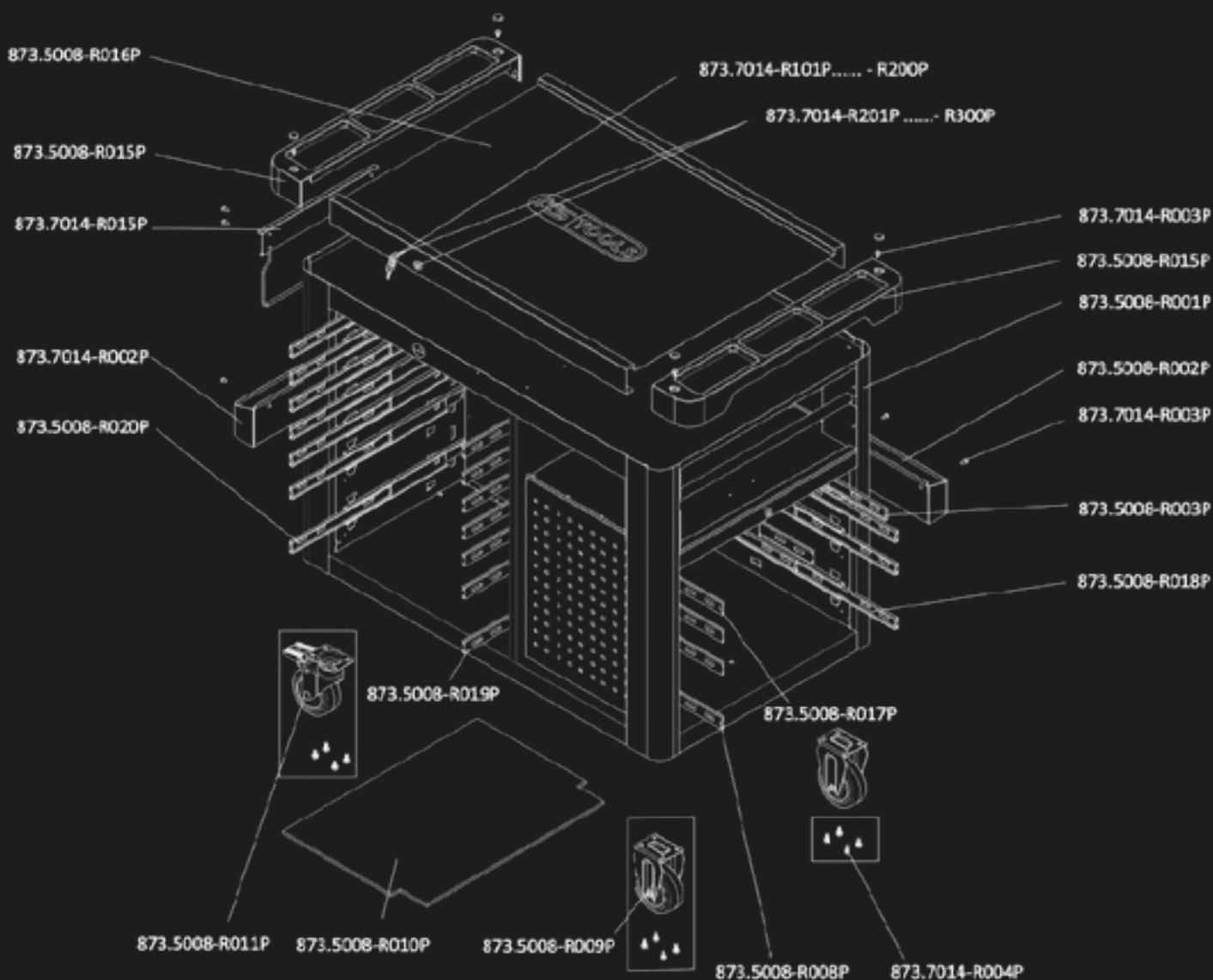

P10

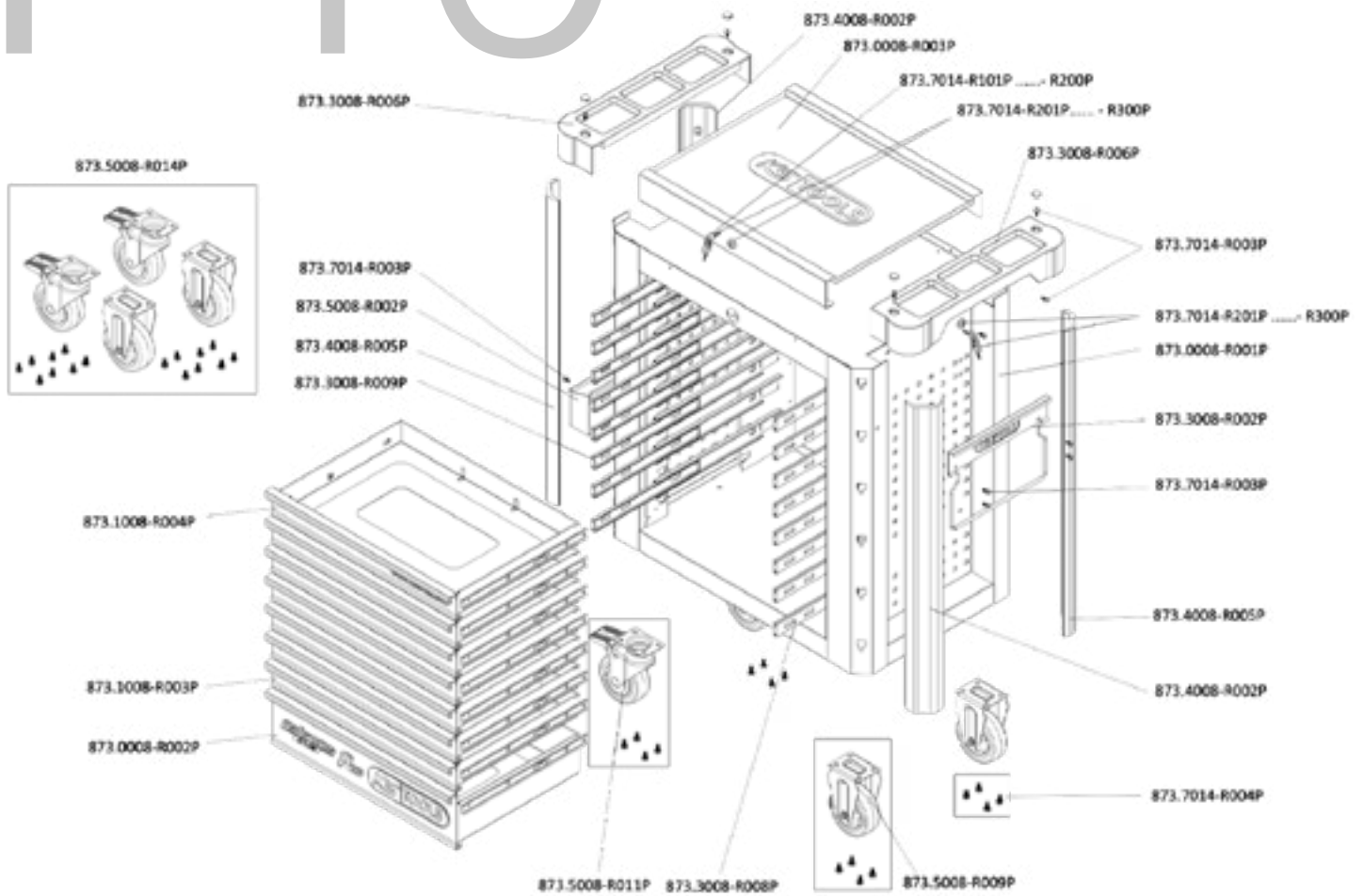

INDIVIDUAL PARTS LIST

Item No.	Description	Amount	Price per piece
873.7014-R101P...	Replacement key for PERFORMANCEplus workshop trolley lock number xyz	2	7,50 €
873.7014-R201P...	Lock with 2 keys for PERFORMANCEplus workshop trolley lock number xyz	2	12,90 €
873.0008-R001P	Body with handle	1	503,90 €
873.0008-R002P	Compartment with logo and ball-bearing guide, 568x398x154 mm	1	142,50 €
873.0008-R003P	Stainless steel worktop	1	126,50 €
873.1008-R003P	Compartment with ball-bearing guide, for workshop trolley P10/P10TC/P15, 568x398x75 mm	6	83,50 €
873.1008-R004P	Compartment with website and ball-bearing guide, for workshop trolley P10/P15, 568x398x75 mm	1	83,50 €
873.3008-R002P	Paper roll holder for PERFORMANCEplus workshop trolley	1	23,50 €
873.3008-R006P	Storage for work surface	2	36,50 €
873.3008-R008P	Full extension (with ball-bearing guide) with automatic retraction	8	36,50 €
873.3008-R009P	Full extension (with ball-bearing guide) with automatic retraction	8	36,50 €
873.4008-R002P	Plastic bumpers	2	23,50 €
873.4008-R005P	Plastic bumpers	2	23,50 €
873.5008-R002P	Can holder for PERFORMANCEplus workshop trolley	1	29,90 €
873.5008-R009P	Fixed castors for PERFORMANCEplus workshop trolley, incl. screws	2	42,90 €
873.5008-R011P	Swivel castors with brakes, for PERFORMANCEplus workshop trolley, incl. screws	2	42,90 €
873.5008-R014P	Roller set for PERFORMANCEplus workshop trolley, incl. screws	1	180,90 €
873.7014-R003P	M6x12 screws for PERFORMANCEplus workshop trolley accessories	14	0,50 €
873.7014-R004P	M8 screws for PERFORMANCEplus workshop trolley rollers (16 pcs.)	1	7,50 €



873.7014-R101P...R200P
Replacement key for lock number xyz

7,50
EUR



873.7014-R201P...R300P
Lock with 2 keys for lock number xyz

12,90
EUR



873.3008-R008P
Full extension (with ball-bearing guide) with automatic retraction, right

36,50
EUR



873.3008-R009P
Full extension (with ball-bearing guide) with automatic retraction, left

36,50
EUR



873.5008-R009P
Fixed castors, incl. screws

42,90
EUR



873.5008-R011P
Swivel castors with brakes, incl. screws

42,90
EUR



873.5008-R014P
Roller set, incl. screws

180,90
EUR



873.0008-R003P
Stainless steel work surface

126,50
EUR



873.3008-R006P
Storage for work surface, including screw cover, usable on both sides

36,50
EUR



873.1008-R004P
Compartment with website and ball-bearing guide, 568x398x75 mm

83,50
EUR



873.1008-R003P
Compartment with ball-bearing guide, 568x398x75 mm

83,50
EUR



873.0008-R002P
Compartment with logo and ball-bearing guide, 568x398x154 mm

142,50
EUR



873.5008-R002P
Can holder, 310 mm

29,90
EUR



873.3008-R002P
Paper roll holder, 320 mm

23,50
EUR



873.4008-R005P
Plastic bumpers, front left, back right

23,50
EUR



873.4008-R002P
Plastic bumpers, front right, back left

23,50
EUR



873.7014-R004P
M8 screws (16 pcs.)

7,50
EUR



873.7014-R003P
M6x12 screw (1 pcs.)

0,50
EUR



873.0008-R001P
Body with handle

503,90
EUR



A thousand great parts for tough guys!



P10TC

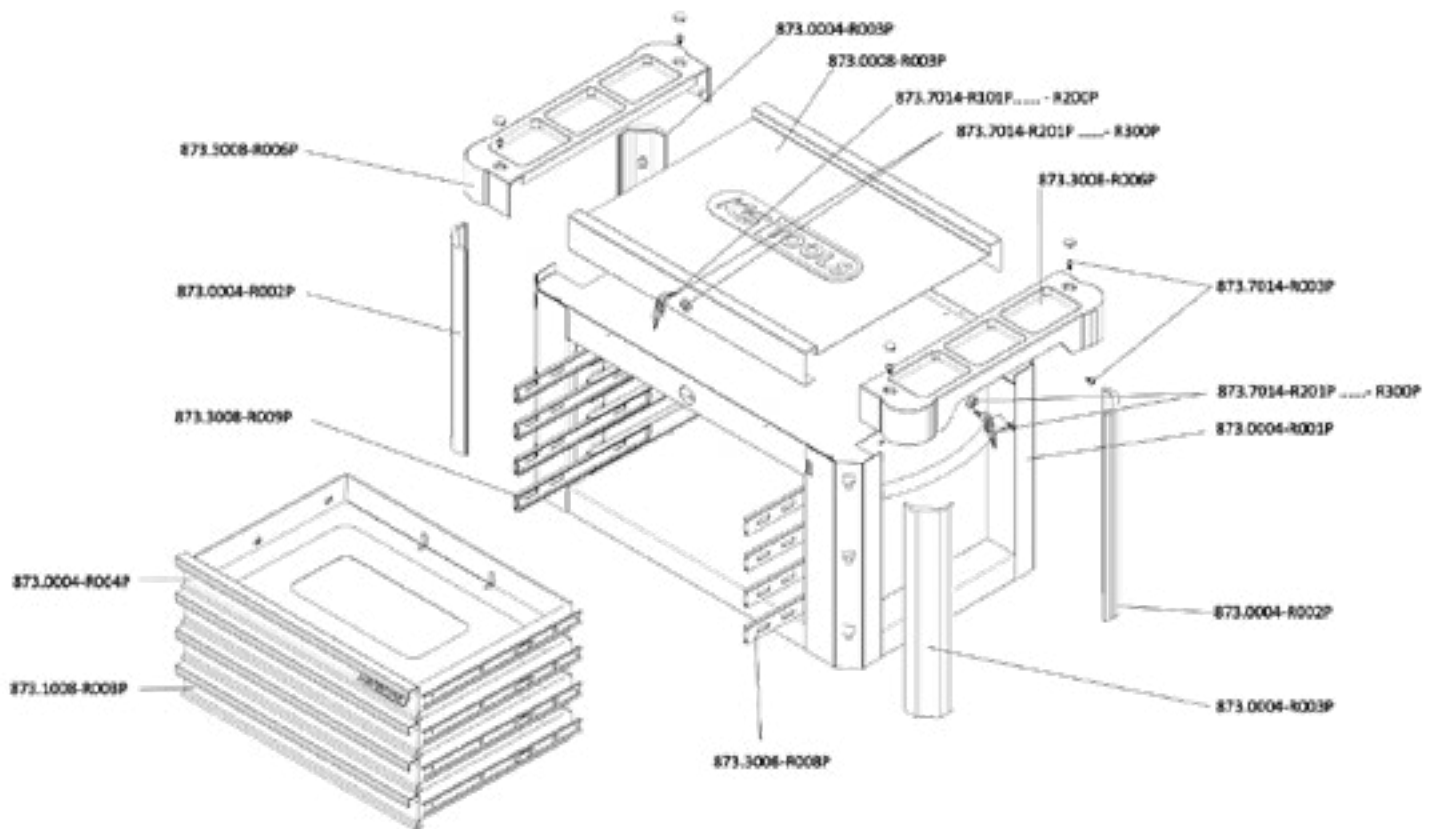

INDIVIDUAL PARTS LIST

Art.-Nr.	Description	amount	Price per piece
873.7014-R101P...	Replacement key for PERFORMANCEplus workshop trolley lock number xyz	2	7,50 €
873.7014-R201P...	Lock with 2 keys for PERFORMANCEplus workshop trolley lock number xyz	2	12,90 €
873.0004-R001P	Body of workshop trolley attachment P10TC	1	348,90 €
873.0004-R002P	Plastic bumpers for workshop trolley attachment P10TC	2	12,90 €
873.0004-R003P	Plastic bumpers for workshop trolley attachment P10TC	2	12,90 €
873.0004-R004P	Compartment with logo and ball-bearing guide, for attachment P10TC, 568x398x75 mm	1	96,50 €
873.0008-R003P	Stainless steel work surface	1	126,50 €
873.1008-R003P	Compartment with ball-bearing guide, for workshop trolley P10/P10TC/P15, 568x398x75 mm	3	83,50 €
873.3008-R006P	Storage for work surface	2	36,50 €
873.3008-R008P	Full extension (with ball-bearing guide) with automatic retraction	4	36,50 €
873.3008-R009P	Full extension (with ball-bearing guide) with automatic retraction	4	36,50 €
873.7014-R003P	M6x12 screws for PERFORMANCEplus workshop trolley accessories	8	0,50 €



7,50
EUR
873.7014-R101P...R200P
Replacement key for lock number xyz



12,90
EUR
873.7014-R201P...R300P
Lock with 2 keys for lock number xyz



36,50
EUR
873.3008-R008P
Full extension (with ball-bearing guide) with automatic retraction, right



36,50
EUR
873.3008-R009P
Full extension (with ball-bearing guide) with automatic retraction, left



126,50
EUR
873.0008-R003P
Stainless steel work surface



36,50
EUR
873.3008-R006P
Storage for work surface, including screw cover, usable on both sides



96,50
EUR
873.0004-R004P
Compartment with logo and ball-bearing guide, for attachment P10TC, 568x398x75 mm

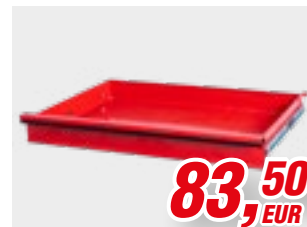

83,50
EUR
873.1008-R003P
Compartment with ball-bearing guide, 568x398x75 mm



12,90
EUR
873.0004-R002P
Plastic bumpers, front left, back right



12,90
EUR
873.0004-R003P
Plastic bumpers, front right, back left



0,50
EUR
873.7014-R003P
M6x12 screw (1 pcs.)



348,90
EUR
873.0004-R001P
Body of workshop trolley attachment

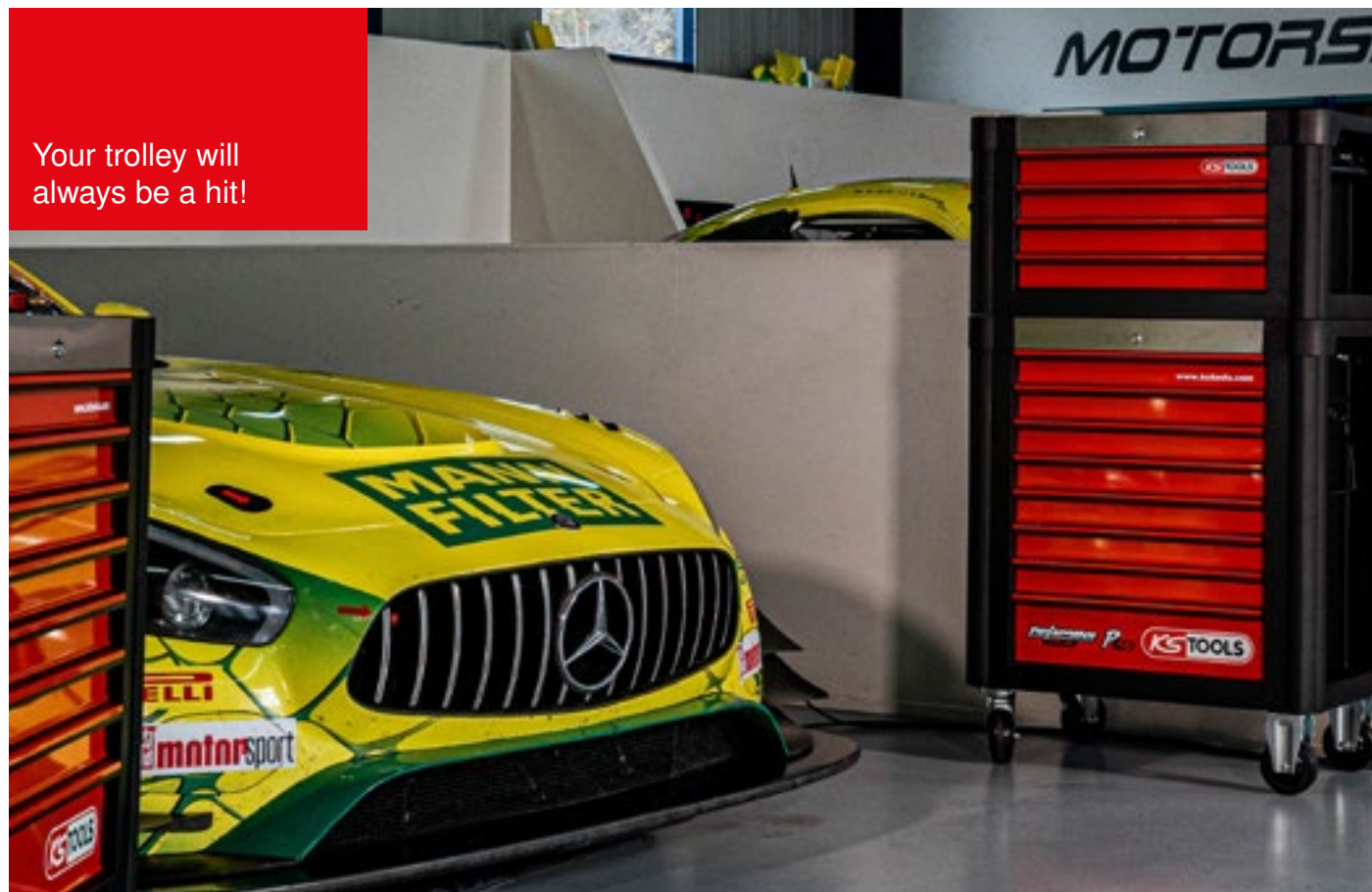

Your trolley will always be a hit!

P15

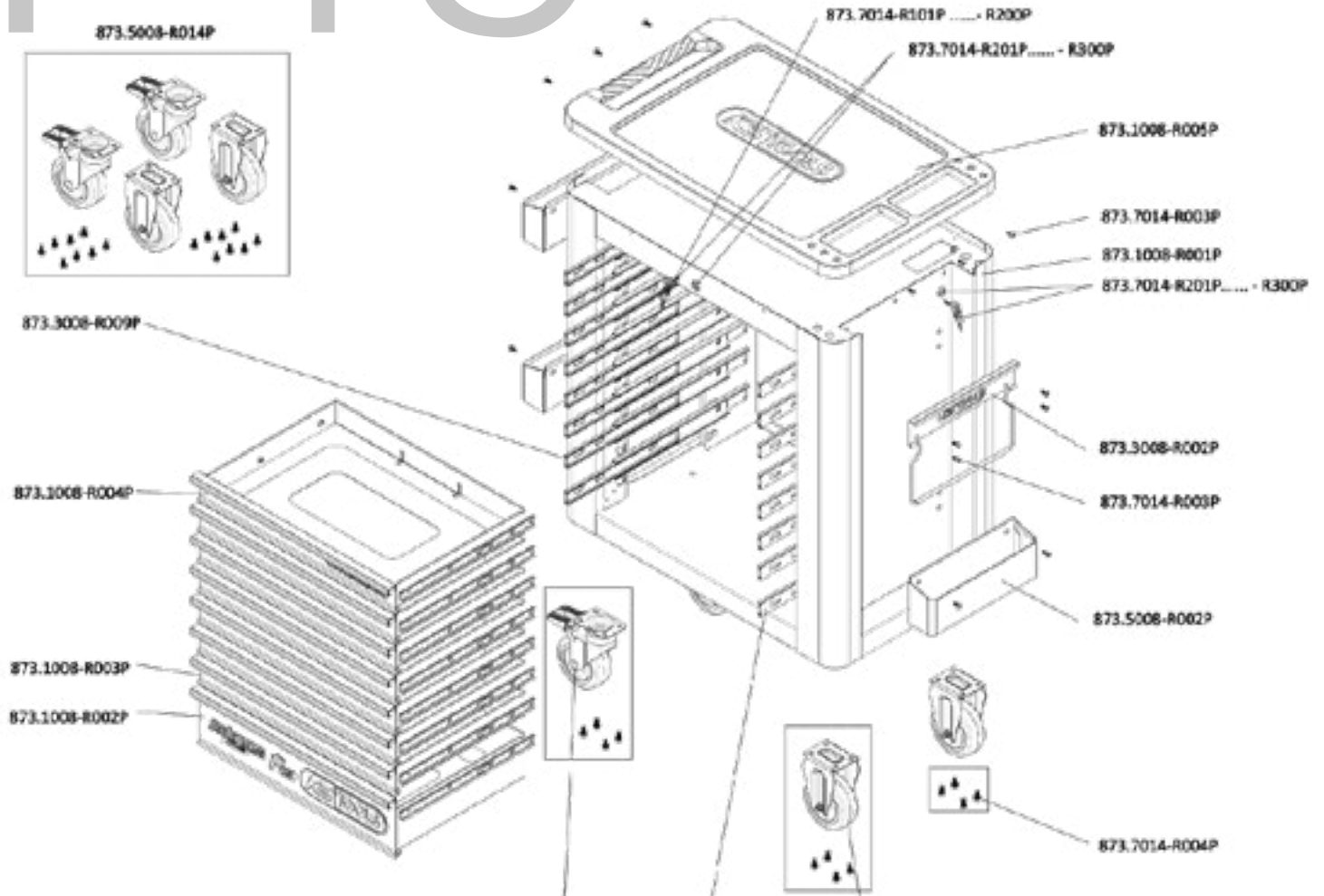

INDIVIDUAL PARTS LIST

Art.-Nr.	Description	amount	Price per piece
873.7014-R101P...	Replacement key for PERFORMANCEplus workshop trolley lock number xyz	2	7,50 €
873.7014-R201P...	Lock with 2 keys for PERFORMANCEplus workshop trolley lock number xyz	2	12,90 €
873.1008-R001P	Body of workshop trolley	1	503,90 €
873.1008-R002P	Compartment with logo and ball-bearing guide, 568x398x154 mm	1	142,50 €
873.1008-R003P	Compartment with ball-bearing guide, for workshop trolley P10/P10TC/P15, 568x398x75 mm	6	83,50 €
873.1008-R004P	Compartment with website and ball-bearing guide, for workshop trolley P10/P15, 568x398x75 mm	1	83,50 €
873.1008-R005P	Plastic work surface with handle	1	174,50 €
873.3008-R002P	Paper roll holder for PERFORMANCEplus workshop trolley P10/P15/P25	1	23,50 €
873.3008-R008P	Full extension (with ball-bearing guide) with automatic retraction	8	36,50 €
873.3008-R009P	Full extension (with ball-bearing guide) with automatic retraction	8	36,50 €
873.5008-R002P	Can holder for PERFORMANCEplus workshop trolley P10/P15/P25/P35	3	29,90 €
873.5008-R009P	Fixed castors for PERFORMANCEplus workshop trolley, incl. screws	2	42,90 €
873.5008-R011P	Swivel castors with brakes, for PERFORMANCEplus workshop trolley, incl. screws	2	42,90 €
873.5008-R014P	Roller set for PERFORMANCEplus workshop trolley, incl. screws	1	180,90 €
873.7014-R003P	M6x12 screw (1 pcs.) for PERFORMANCEplus workshop trolley accessories	16	0,50 €
873.7014-R004P	M8 screws for PERFORMANCEplus workshop trolley rollers (16 pcs.)	1	7,50 €



873.7014-R101P...R200P
Replacement key for lock number xyz

7,50
EUR



873.7014-R201P...R300P
Lock with 2 keys, lock number xyz

12,90
EUR



873.3008-R008P
Full extension (with ball-bearing guide) with automatic retraction, right

36,50
EUR



873.3008-R009P
Full extension (with ball-bearing guide) with automatic retraction, left

36,50
EUR



873.5008-R009P
Fixed castors, incl. screws

42,90
EUR



873.5008-R011P
Swivel castors with brakes, incl. screws

42,90
EUR



873.5008-R014P
Roller set, incl. screws

180,90
EUR



873.1008-R005P
Plastic work surface with handle

174,50
EUR



873.1008-R004P
Compartment with website and ball-bearing guide, 568x398x75 mm

83,50
EUR



873.1008-R003P
Compartment with ball-bearing guide, 568x398x75 mm

83,50
EUR



873.1008-R002P
Compartment with logo and ball-bearing guide, 568x398x154 mm

142,50
EUR



873.5008-R002P
Can holder including screws, W = 310 mm

29,90
EUR



873.3008-R002P
Paper roll holder including screws, W= 320 mm

23,50
EUR



873.7014-R004P
M8 screws (16 pcs.)

7,50
EUR



873.7014-R003P
M6x12 screw (1 pcs.)

0,50
EUR



873.1008-R001P
Body of workshop trolley

503,90
EUR



The only thing that
can't be replaced is
the quality!

P20

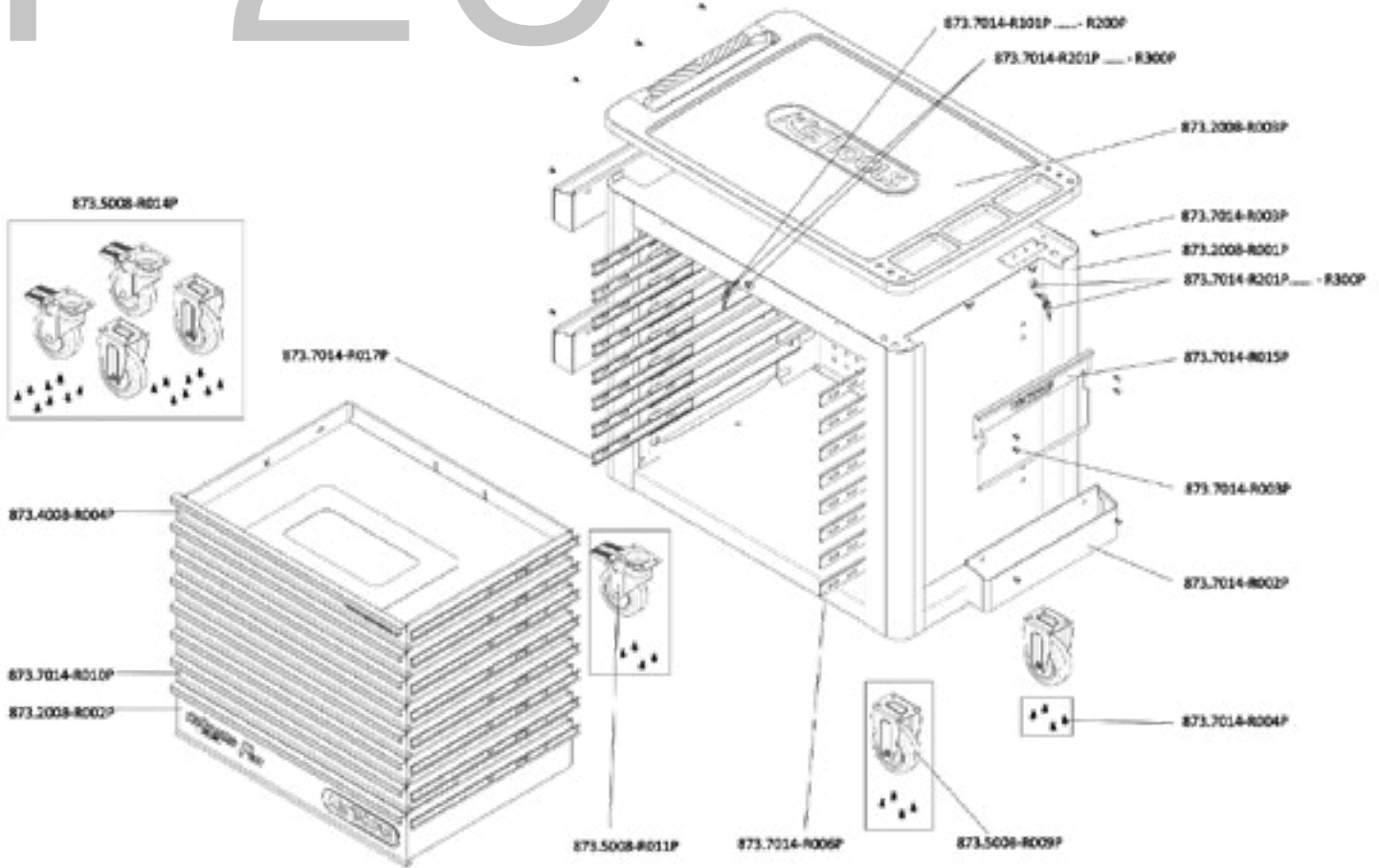

INDIVIDUAL PARTS LIST

Art.-Nr.	Description	amount	Price per piece
873.7014-R101P...	Replacement key for PERFORMANCEplus workshop trolley lock number xyz	2	7,50 €
873.7014-R201P...	Lock with 2 keys for PERFORMANCEplus workshop trolley lock number xyz	2	12,90 €
873.2008-R001P	Body of workshop trolley	1	587,50 €
873.2008-R002P	Compartment with logo and ball-bearing guide, 755x568x154 mm	1	200,50 €
873.2008-R003P	Plastic work surface with handle	1	264,50 €
873.4008-R004P	Compartment with website and ball-bearing guide, for workshop trolley P20/P30, 790x568x75 mm	1	142,50 €
873.5008-R009P	Fixed castors for PERFORMANCEplus workshop trolley, incl. screws	2	42,90 €
873.5008-R011P	Swivel castors with brakes, for PERFORMANCEplus workshop trolley, incl. screws	2	42,90 €
873.5008-R014P	Roller set for PERFORMANCEplus workshop trolley, incl. screws	1	180,90 €
873.7014-R002P	Can holder for PERFORMANCEplus workshop trolley P20/P30/P35/P40/P45	3	42,90 €
873.7014-R003P	M6x12 screw (1 pcs.) for PERFORMANCEplus workshop trolley accessories	16	0,50 €
873.7014-R004P	M8 screws for PERFORMANCEplus workshop trolley rollers (16 pcs.)	1	7,50 €
873.7014-R006P	Full extension (with ball-bearing guide) with automatic retraction	8	23,50 €
873.7014-R010P	Compartment with ball-bearing guide, for workshop trolley P20/P30/P45, 790x568x75 mm	6	113,50 €
873.7014-R015P	Paper roll holder for PERFORMANCEplus workshop trolley P20/P30/P35/P40/P45	1	29,90 €
873.7014-R017P	Full extension (with ball-bearing guide) with automatic retraction	8	23,50 €



873.7014-R101P...R200P
Replacement key for lock number xyz

7,50
EUR



873.7014-R201P...R300P
Lock with 2 keys, lock number xyz

12,90
EUR



873.7014-R006P
Full extension (with ball-bearing guide) with automatic retraction, right

23,50
EUR



873.7014-R017P
Full extension (with ball-bearing guide) with automatic retraction, left

23,50
EUR



873.5008-R009P
Fixed castors, incl. screws

42,90
EUR



873.5008-R011P
Swivel castors with brakes, incl. screws

42,90
EUR



873.5008-R014P
Roller set, incl. screws

180,90
EUR



873.2008-R003P
Plastic work surface with handle

264,50
EUR



873.4008-R004P
Compartment with website and ball-bearing guide, 790x568x75 mm

142,50
EUR



873.7014-R010P
Compartment with ball-bearing guide, 790x568x75 mm

113,50
EUR



873.2008-R002P
Compartment with logo and ball-bearing guide, 755x568x154 mm

200,50
EUR



873.7014-R002P
Can holder including screws, W = 445 mm

42,90
EUR



873.7014-R015P
Paper roll holder including screws, W= 400 mm

29,90
EUR



873.7014-R004P
M8 screws (16 pcs.)

7,50
EUR



873.7014-R003P
M6x12 screw (1 pcs.)

0,50
EUR



873.2008-R001P
Body of workshop trolley

587,50
EUR



„Doesn't exist“
doesn't exist!

P25

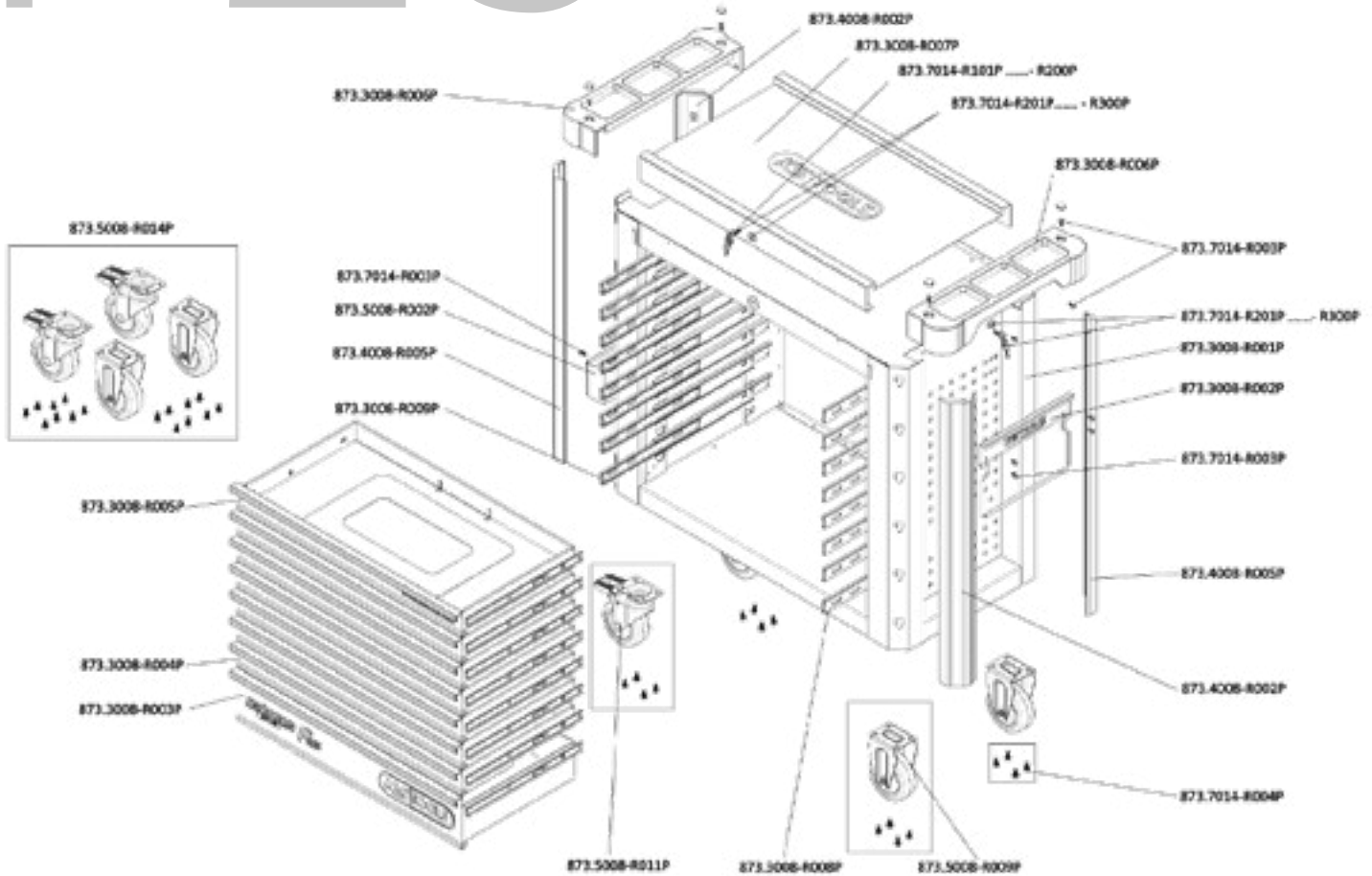

INDIVIDUAL PARTS LIST

Art.-Nr.	Description	amount	Price per piece
873.7014-R101P...	Replacement key for PERFORMANCEplus workshop trolley lock number xyz	2	7,50 €
873.7014-R201P...	Lock with 2 keys for PERFORMANCEplus workshop trolley lock number xyz	2	12,90 €
873.3008-R001P	Body with handle	1	561,90 €
873.3008-R002P	Paper roll holder for PERFORMANCEplus workshop trolley P10/P15/P25	1	23,50 €
873.3008-R003P	Compartment with logo and ball-bearing guide, 755x398x154 mm	1	167,90 €
873.3008-R004P	Compartment with ball-bearing guide, 755x398x75 mm	6	96,50 €
873.3008-R005P	Compartment with website and ball-bearing guide, 755x398x75 mm	1	96,50 €
873.3008-R006P	Storage for work surface	2	36,50 €
873.3008-R007P	Stainless steel work surface	1	155,50 €
873.3008-R008P	Full extension (with ball-bearing guide) with automatic retraction	8	36,50 €
873.3008-R009P	Full extension (with ball-bearing guide) with automatic retraction	8	36,50 €
873.4008-R002P	Plastic bumpers	2	23,50 €
873.4008-R005P	Plastic bumpers	2	23,50 €
873.5008-R002P	Can holder for PERFORMANCEplus workshop trolley P10/P15/P25/P35	1	29,90 €
873.5008-R009P	Fixed castors for PERFORMANCEplus workshop trolley, incl. screws	2	42,90 €
873.5008-R011P	Swivel castors with brakes, for PERFORMANCEplus workshop trolley, incl. screws	2	42,90 €
873.5008-R014P	Roller set for PERFORMANCEplus workshop trolley, incl. screws	1	180,90 €
873.7014-R003P	M6x12 screw (1 pcs.) for PERFORMANCEplus workshop trolley accessories	14	0,50 €
873.7014-R004P	M8 screws for PERFORMANCEplus workshop trolley rollers (16 pcs.)	1	7,50 €



873.7014-R101P...R200P
Replacement key for lock number xyz

7,50
EUR



873.7014-R201P...R300P
Lock with 2 keys, lock number xyz

12,90
EUR



873.3008-R008P
Full extension (with ball-bearing guide) with automatic retraction, right

36,50
EUR



873.3008-R009P
Full extension with self-closing, for drawer, left

36,50
EUR



873.5008-R009P
Fixed castors, incl. screws

42,90
EUR



873.5008-R011P
Swivel castors with brakes, incl. screws

42,90
EUR



873.5008-R014P
Roller set, incl. screws

180,90
EUR



873.3008-R007P
Stainless steel work surface

155,50
EUR



873.3008-R006P
Storage for work surface, including screw cover, usable on both sides

36,50
EUR



873.3008-R005P
Compartment with website and ball-bearing guide, 755x398x75 mm

96,50
EUR



873.3008-R004P
Compartment with ball-bearing guide, 755x398x75 mm

96,50
EUR



873.3008-R003P
Compartment with logo and ball-bearing guide, 755x398x154 mm

167,90
EUR



873.5008-R002P
Can holder including screws, W = 310 mm

29,90
EUR



873.3008-R002P
Paper roll holder including screws, W= 320 mm

23,50
EUR



873.4008-R005P
Plastic bumpers, front left, back right

23,50
EUR



873.4008-R002P
Plastic bumpers, front right, back left

23,50
EUR



873.7014-R004P
M8 screws (16 pcs.)

7,50
EUR



873.7014-R003P
M6x12 screw (1 pcs.)

0,50
EUR



873.3008-R001P
Body of workshop trolley attachment

561,90
EUR



Enough spares for
your treasure!

P30

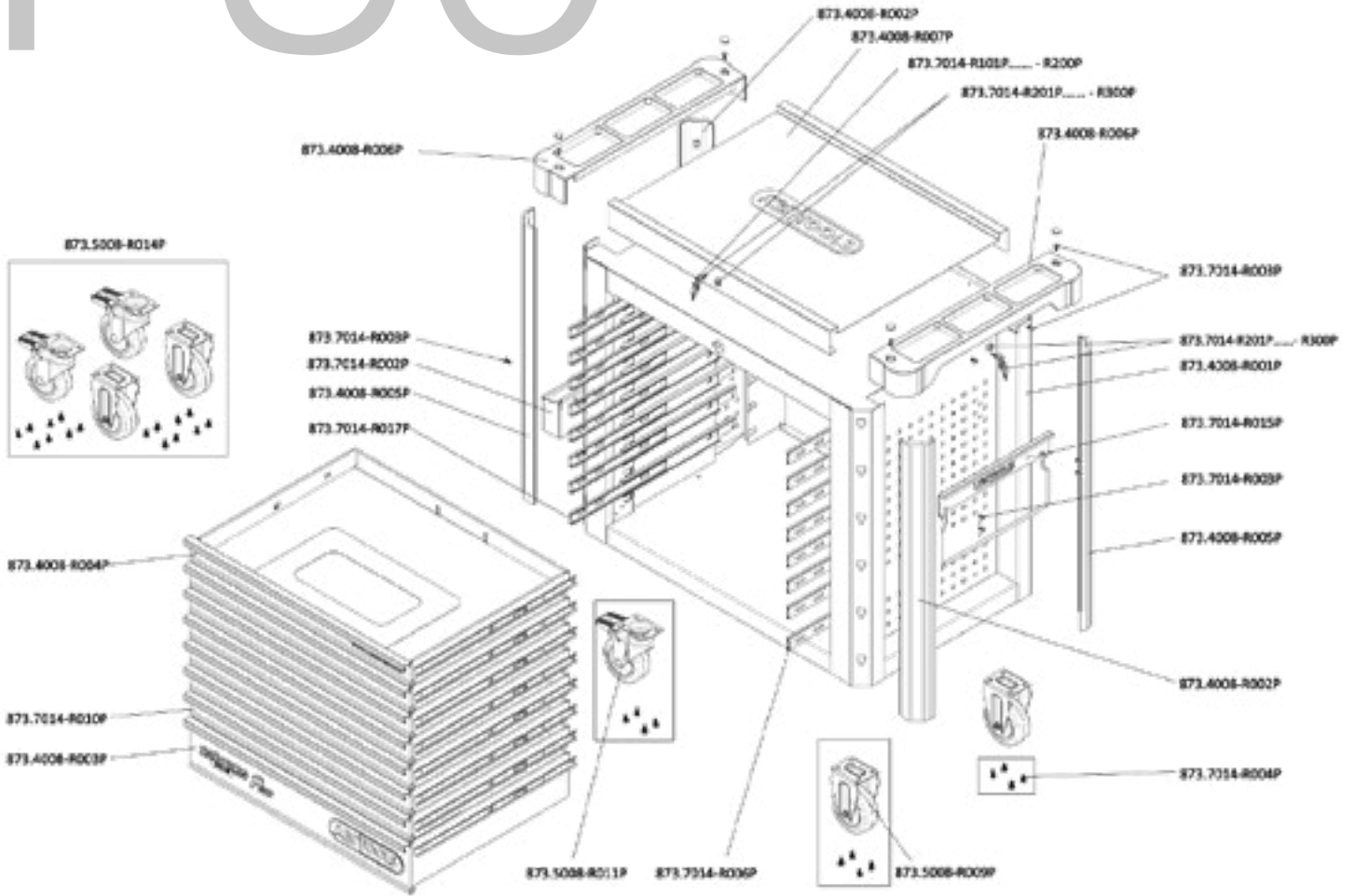

INDIVIDUAL PARTS LIST

Art.-Nr.	Description	amount	Price per piece
873.7014-R101P...	Replacement key for PERFORMANCEplus workshop trolley lock number xyz	2	7,50 €
873.7014-R201P...	Lock with 2 keys for PERFORMANCEplus workshop trolley lock number xyz	2	12,90 €
873.4008-R001P	Body with handle	1	600,50 €
873.4008-R002P	Plastic bumpers	2	23,50 €
873.4008-R003P	Compartment with logo and ball-bearing guide, 790x568x154 mm	1	200,50 €
873.4008-R004P	Compartment with website and ball-bearing guide, for workshop trolley P20/P30, 790x568x75 mm	1	142,50 €
873.4008-R005P	Plastic bumpers	2	23,50 €
873.4008-R006P	Storage for work surface	2	102,90 €
873.4008-R007P	Stainless steel work surface	1	180,90 €
873.5008-R009P	Fixed castors for PERFORMANCEplus workshop trolley, incl. screws	2	42,90 €
873.5008-R011P	Swivel castors with brakes for PERFORMANCEplus workshop trolley, incl. screws	2	42,90 €
873.5008-R014P	Roller set for PERFORMANCEplus workshop trolley, incl. screws	1	180,90 €
873.7014-R002P	Can holder for PERFORMANCEplus workshop trolley P20/P30/P35/P40/P45	1	42,90 €
873.7014-R003P	M6x12 screw (1 pcs.) for PERFORMANCEplus workshop trolley accessories	14	0,50 €
873.7014-R004P	M8 screws for PERFORMANCEplus workshop trolley rollers (16 pcs.)	1	7,50 €
873.7014-R006P	Full extension (with ball-bearing guide) with automatic retraction	8	23,50 €
873.7014-R010P	Compartment with ball-bearing guide, for workshop trolley P20/P30/P45, 790x568x75 mm	6	113,50 €
873.7014-R015P	Paper roll holder for PERFORMANCEplus workshop trolley P20/P30/P35/P40/P45	1	29,90 €
873.7014-R017P	Full extension (with ball-bearing guide) with automatic retraction	8	23,50 €



873.7014-R101P...R200P
Replacement key for lock number xyz

7,50
EUR



873.7014-R201P...R300P
Lock with 2 keys, lock number xyz

12,90
EUR



873.7014-R006P
Full extension (with ball-bearing guide) with automatic retraction, right

23,50
EUR



873.7014-R017P
Full extension (with ball-bearing guide) with automatic retraction, left

23,50
EUR



873.5008-R009P
Fixed castors, incl. screws

42,90
EUR



873.5008-R011P
Swivel castors with brakes, incl. screws

42,90
EUR



873.5008-R014P
Roller set, incl. screws

180,90
EUR



873.4008-R007P
Stainless steel work surface

180,90
EUR



873.4008-R006P
Storage for work surface, including screw cover, usable on both sides

102,90
EUR



873.4008-R004P
Compartment with website and ball-bearing guide, 790x568x75 mm

142,50
EUR



873.7014-R010P
Compartment with ball-bearing guide, 790x568x75 mm

113,50
EUR



873.4008-R003P
Compartment with logo and ball-bearing guide, 790x568x154 mm

200,50
EUR



873.7014-R002P
Can holder including screws, W = 445 mm

42,90
EUR



873.7014-R015P
Paper roll holder including screws, W= 400 mm

29,90
EUR



873.4008-R005P
Plastic bumpers, front left, back right

23,50
EUR



873.4008-R002P
Plastic bumpers, front right, back left

23,50
EUR



873.7014-R004P
M8 screws (16 pcs.)

7,50
EUR



873.7014-R003P
M6x12 screw (1 pcs.)

0,50
EUR



873.4008-R001P
Body of workshop trolley attachment

600,50
EUR



Strong parts for the great trolley!

P35

873.5008-R014P

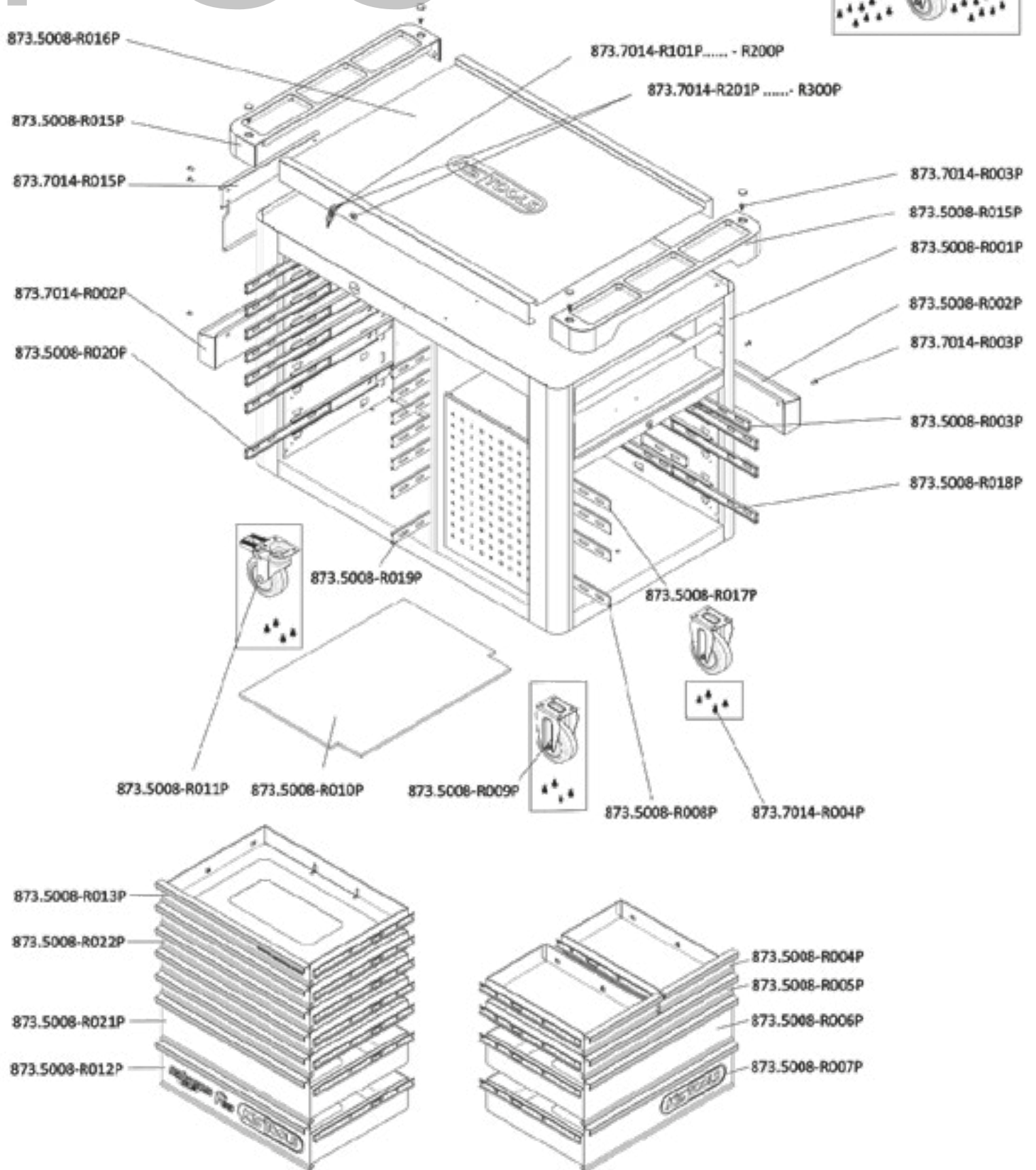



INDIVIDUAL PARTS LIST

Art.-Nr.	Description	amount	Price per piece
873.7014-R101P...	Replacement key for PERFORMANCEplus workshop trolley lock number xyz	2	7,50 €
873.7014-R201P...	Lock with 2 keys for PERFORMANCEplus workshop trolley lock number xyz	2	12,90 €
873.5008-R001P	Body with handle	1	1.227,50 €
873.5008-R002P	Can holder for PERFORMANCEplus workshop trolley P10/P15/P25/P35	1	29,90 €
873.5008-R003P	Full extension (with ball-bearing guide) with automatic retraction	2	12,90 €
873.5008-R004P	Compartment with ball-bearing guide, 268x398x75 mm	2	70,90 €
873.5008-R005P	Compartment with ball-bearing guide, 568x398x75 mm	1	83,50 €
873.5008-R006P	Compartment with ball-bearing guide, 568x398x154 mm	1	142,50 €
873.5008-R007P	Compartment with logo and ball-bearing guide, 568x398x154 mm	1	142,50 €
873.5008-R008P	Full extension (with ball-bearing guide) with automatic retraction	3	12,90 €
873.5008-R009P	Fixed castors for PERFORMANCEplus workshop trolley, incl. screws	2	42,90 €
873.5008-R010P	Foam support	1	29,90 €
873.5008-R011P	Swivel castors with brakes, for PERFORMANCEplus workshop trolley, incl. screws	2	42,90 €
873.5008-R012P	Compartment with logo and ball-bearing guide, 568x398x154 mm	1	142,50 €
873.5008-R013P	Compartment with website and ball-bearing guide, 568x398x75 mm	1	83,50 €
873.5008-R014P	Roller set for PERFORMANCEplus workshop trolley, incl. screws	1	180,90 €
873.5008-R015P	Storage for work surface	2	49,50 €
873.5008-R016P	Stainless steel work surface	1	251,50 €
873.5008-R017P	Full extension (with ball-bearing guide) with automatic retraction	2	23,50 €
873.5008-R018P	Full extension (with ball-bearing guide) with automatic retraction	3	23,50 €
873.5008-R019P	Full extension (with ball-bearing guide) with automatic retraction	7	23,50 €
873.5008-R020P	Full extension (with ball-bearing guide) with automatic retraction	7	23,50 €
873.5008-R021P	Compartment with ball-bearing guide, 568x398x154 mm	1	142,50 €
873.5008-R022P	Compartment with ball-bearing guide, 568x398x75 mm	4	83,50 €
873.7014-R002P	Can holder for PERFORMANCEplus workshop trolley P20/P30/P35/P40/P45	1	42,90 €
873.7014-R003P	M6x12 screw (1 pcs.) for PERFORMANCEplus workshop trolley accessories	12	0,50 €
873.7014-R004P	M8 screws for PERFORMANCEplus workshop trolley rollers (16 pcs.)	1	7,50 €
873.7014-R015P	Paper roll holder for PERFORMANCEplus workshop trolley P20/P30/P35/P40/P45	1	29,90 €

P35



7,50
EUR

873.7014-R101P...R200P
Replacement key for lock number xyz



12,90
EUR

873.7014-R201P...R300P
Lock with 2 keys, lock number xyz



12,90
EUR

873.5008-R003P
Full extension (with ball-bearing guide) with automatic retraction, right



12,90
EUR

873.5008-R008P
Full extension with self-closing for drawer, left

Top performance,
even from the
spare parts!



23,50
EUR

873.5008-R019P
Full extension with self-closing for drawer, right



23,50
EUR

873.5008-R020P
Full extension with self-closing for drawer, left



23,50
EUR

873.5008-R018P
Full extension with self-closing for drawer, right



23,50
EUR

873.5008-R017P
Full extension with self-closing for drawer, left



42,90
EUR

873.5008-R009P
Fixed castors, incl. screws



42,90
EUR

873.5008-R011P
Swivel castors with brakes, incl. screws



180,90
EUR

873.5008-R014P
Roller set, incl. screws



251,50
EUR

873.5008-R016P
Stainless steel work surface



29,90
EUR

873.5008-R010P
Foam support, 8 mm



49,50
EUR

873.5008-R015P
Storage for work surface, including screw cover, usable on both sides

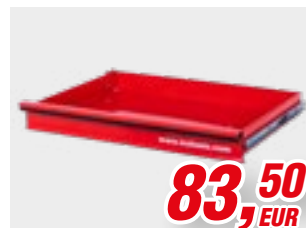

83,50
EUR

873.5008-R013P
Compartment with website and ball-bearing guide, 568x398x75 mm



83,50
EUR

873.5008-R005P
Compartment with ball-bearing guide, 568x398x75 mm

performance
plus

DIE NEUE PREMIUMKLASSE DER WERKSTATTWAGEN

THE NEW PREMIUM CLASS FOR WORKSHOP TROLLEYS

www.myperformanceplus.de

P 10

P 15

P 20

P 25

P 30

P 35

P 40

P 45

Individual parts

Accessories



142,50
EUR

873.5008-R006P
Compartment with ball-bearing
guide, 568x398x154 mm



142,50
EUR

873.5008-R012P
Compartment with logo and ball-
bearing guide, 568x398x154 mm



70,90
EUR

873.5008-R004P
Compartment with ball-bearing
guide, 268x398x75 mm



83,50
EUR

873.5008-R022P
Compartment with ball-bearing
guide, 568x398x75 mm



142,50
EUR

873.5008-R021P
Compartment with ball-bearing
guide, 568x398x154 mm



142,50
EUR

873.5008-R007P
Compartment with logo and ball-
bearing guide, 568x398x154 mm



29,90
EUR

873.5008-R002P
Can holder including screws,
W = 310 mm



42,90
EUR

873.7014-R002P
Can holder including screws,
W = 445 mm



29,90
EUR

873.7014-R015P
Paper roll holder including screws,
W = 400 mm



7,50
EUR

873.7014-R004P
M8 screws (16 pcs.)



0,50
EUR

873.7014-R003P
M6x12 screw (1 pcs.)



1.227,50
EUR

873.5008-R001P
Body of workshop trolley attachment

P40

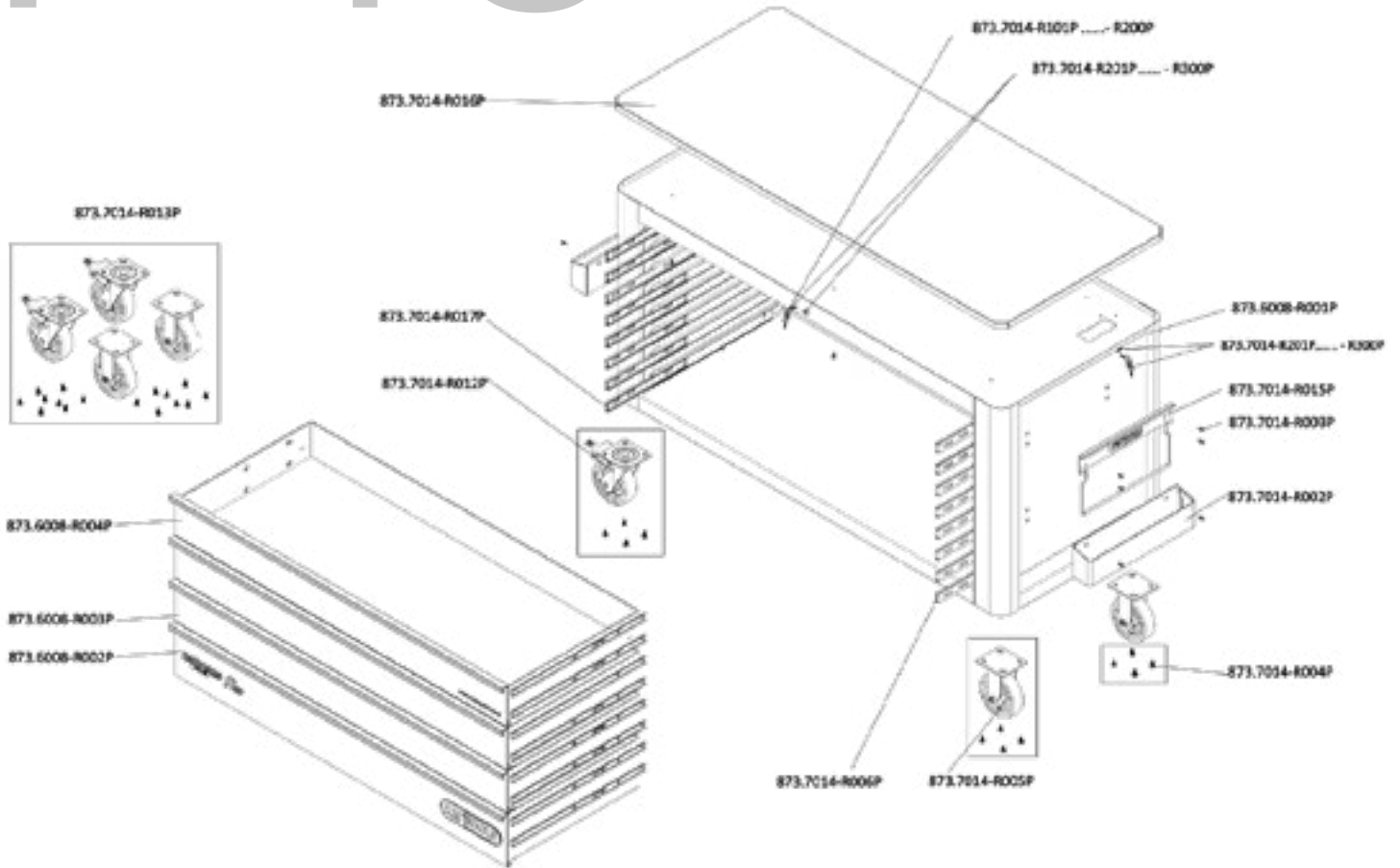

INDIVIDUAL PARTS LIST

Art.-Nr.	Description	amount	Price per piece
873.7014-R101P...	Replacement key for PERFORMANCEplus workshop trolley lock number xyz	2	7,50 €
873.7014-R201P...	Lock with 2 keys for PERFORMANCEplus workshop trolley lock number xyz	2	12,90 €
873.6008-R001P	Body with handle for workshop trolley P40	1	1.143,90 €
873.6008-R002P	Compartment with logo and ball-bearing guide, 1429x568x197 mm	1	380,90 €
873.6008-R003P	Compartment with ball-bearing guide, 1429x568x154 mm	2	284,90 €
873.6008-R004P	Compartment with website and ball-bearing guide, 1429x568x154 mm	1	284,90 €
873.7014-R002P	Can holder for PERFORMANCEplus workshop trolley P20/P30/P35/P40/P45	3	42,90 €
873.7014-R003P	M6x12 screw (1 pcs.) for PERFORMANCEplus workshop trolley accessories	10	0,50 €
873.7014-R004P	M8 screws for PERFORMANCEplus workshop trolley rollers (16 pcs.)	1	7,50 €
873.7014-R005P	Fixed castors for workshop trolley P45, incl. screws	2	55,90 €
873.7014-R006P	Full extension (with ball-bearing guide) with automatic retraction	8	23,50 €
873.7014-R012P	Swivel castors for workshop trolley P45, incl. screws	2	62,50 €
873.7014-R013P	Roller set for workshop trolley P45, incl. screws	1	238,90 €
873.7014-R017P	Full extension (with ball-bearing guide) with automatic retraction	8	23,50 €
873.7014-R015P	Paper roll holder for PERFORMANCEplus workshop trolley P20/P30/P35/P40/P45	1	29,90 €
873.7014-R016P	Stainless steel work surface for workshop trolley P45	1	781,50 €



873.7014-R101P...R200P
Replacement key for lock number xyz

7,50
EUR



873.7014-R201P...R300P
Lock with 2 keys, lock number xyz

12,90
EUR



873.7014-R006P
Full extension (with ball-bearing guide) with automatic retraction, right

23,50
EUR



873.7014-R017P
Full extension (with ball-bearing guide) with automatic retraction, left

23,50
EUR



873.7014-R005P
Fixed castors, incl. screws

55,90
EUR



873.7014-R012P
Swivel castors with brakes, incl. screws

62,50
EUR



873.7014-R013P
Roller set, incl. screws

238,90
EUR



873.7014-R016P
Stainless steel work surface

781,50
EUR



873.6008-R004P
Compartment with website and ball-bearing guide, 1429x568x154 mm

284,90
EUR



873.6008-R003P
Compartment with ball-bearing guide, 1429x568x154 mm

284,90
EUR



873.6008-R002P
Compartment with logo and ball-bearing guide, 1429x568x197 mm

380,90
EUR



873.7014-R002P
Can holder including screws, W = 445 mm

42,90
EUR



873.7014-R015P
Paper roll holder including screws, W = 400 mm

29,90
EUR



873.7014-R004P
M8 screws (16 pcs.)

7,50
EUR



873.7014-R003P
M6x12 screw (1 pcs.)

0,50
EUR



873.6008-R001P
Body of workshop trolley attachment

1.143,90
EUR



Always like new
thanks to perfect
parts!

P45

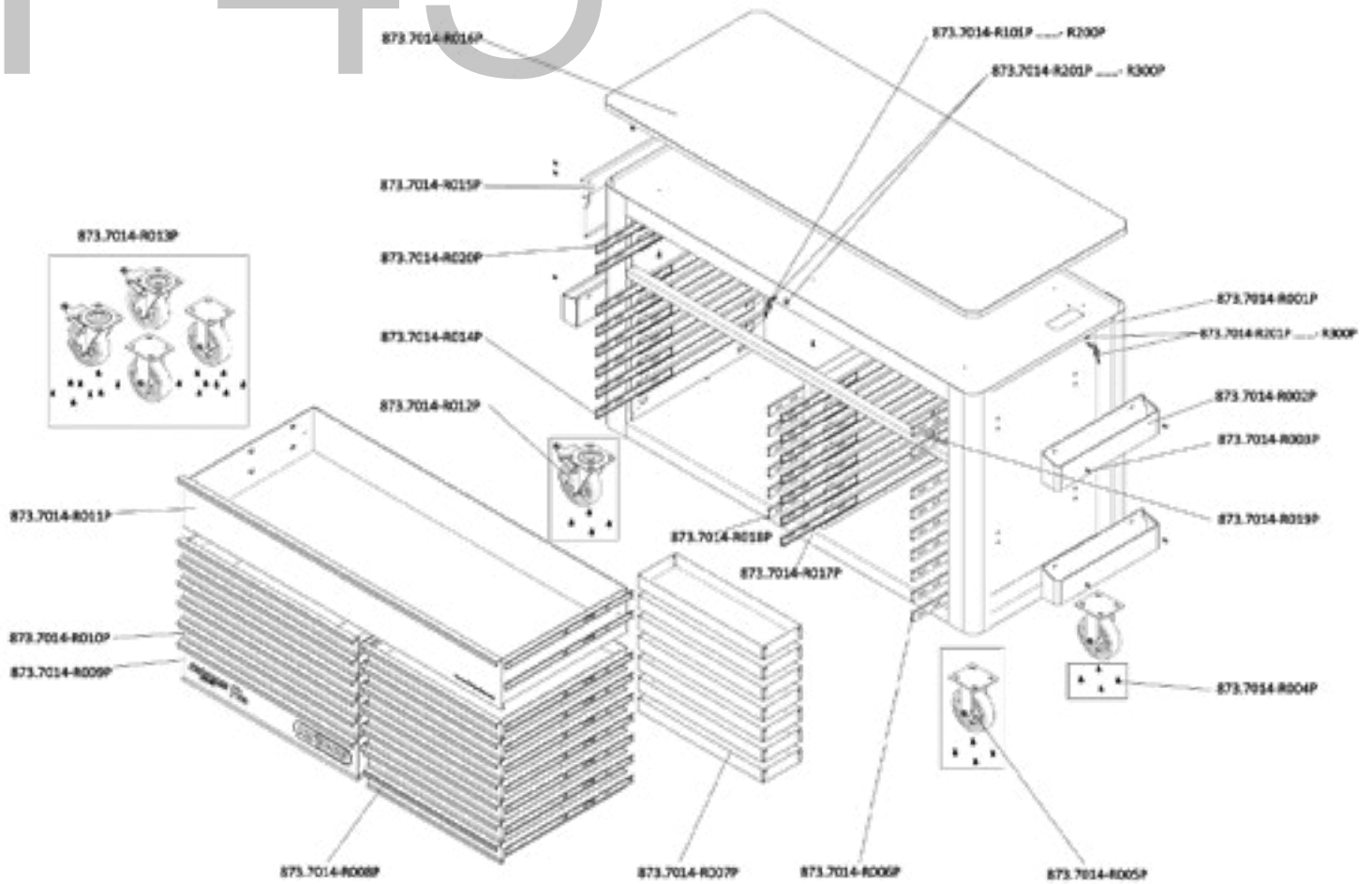

INDIVIDUAL PARTS LIST

Art.-Nr.	Description	amount	Price per piece
873.7014-R101P...	Replacement key for PERFORMANCEplus workshop trolley lock number xyz	2	7,50 €
873.7014-R201P...	Lock with 2 keys for PERFORMANCEplus workshop trolley lock number xyz	2	12,90 €
873.7014-R001P	Body with handle for workshop trolley P45	1	1.355,90 €
873.7014-R002P	Can holder for PERFORMANCEplus workshop trolley P20/P30/P35/P40/P45	3	42,90 €
873.7014-R003P	M6x12 screw (1 pcs.) for PERFORMANCEplus workshop trolley accessories	10	0,50 €
873.7014-R004P	M8 screws for PERFORMANCEplus workshop trolley rollers (16 pcs.)	1	7,50 €
873.7014-R005P	Fixed castors for workshop trolley P45, incl. screws	2	55,90 €
873.7014-R006P	Full extension (with ball-bearing guide) with automatic retraction	7	23,50 €
873.7014-R007P	Storage for compartments for workshop trolley P45	7	23,50 €
873.7014-R008P	Compartment with ball-bearing guide, 568x568x75 mm	7	96,50 €
873.7014-R009P	Compartment with logo and ball-bearing guide, 790x568x154 mm	1	200,50 €
873.7014-R010P	Compartment with ball-bearing guide, for workshop trolley P20/P30/P45, 790x568x75 mm	5	113,50 €
873.7014-R011P	Compartment with website and ball-bearing guide, 1429x568x197 mm	1	284,90 €
873.7014-R012P	Swivel castors for workshop trolley P45, incl. screws	2	62,50 €
873.7014-R013P	Roller set for workshop trolley P45, incl. screws	1	238,90 €
873.7014-R014P	Full extension (with ball-bearing guide) with automatic retraction	6	23,50 €
873.7014-R015P	Paper roll holder for PERFORMANCEplus workshop trolley P20/P30/P35/P40/P45	1	29,90 €
873.7014-R016P	Stainless steel work surface for workshop trolley P45	1	781,50 €
873.7014-R017P	Full extension (with ball-bearing guide) with automatic retraction	7	23,50 €
873.7014-R018P	Full extension (with ball-bearing guide) with automatic retraction	6	23,50 €
873.7014-R019P	Full extension (with ball-bearing guide) with automatic retraction	2	23,50 €
873.7014-R020P	Full extension (with ball-bearing guide) with automatic retraction	2	23,50 €



873.7014-R101P...R200P
Replacement key for lock number xyz

7,50
EUR



873.7014-R201P...R300P
Lock with 2 keys, lock number xyz

12,90
EUR



873.7014-R006P
Full extension (with ball-bearing guide) with automatic retraction, right

23,50
EUR



873.7014-R014P
Full extension (with ball-bearing guide) with automatic retraction, left

23,50
EUR



873.7014-R017P
Full extension (with ball-bearing guide) with automatic retraction, left

23,50
EUR



873.7014-R018P
Full extension with self-closing for drawer, right

23,50
EUR



873.7014-R019P
Full extension (with ball-bearing guide) with automatic retraction, right

23,50
EUR



873.7014-R020P
Full extension with self-closing for drawer, left

23,50
EUR



873.7014-R005P
Fixed castors, incl. screws

55,90
EUR



873.7014-R012P
Swivel castors with brakes, incl. screws

62,50
EUR



873.7014-R013P
Roller set, incl. screws

238,90
EUR



873.7014-R016P
Stainless steel work surface

781,50
EUR



873.7014-R011P
Compartment with website and ball-bearing guide, 1429x568x197 mm

284,90
EUR

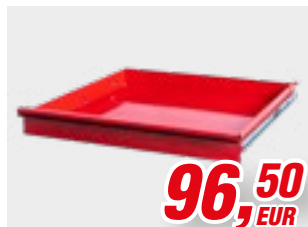

873.7014-R008P
Compartment with ball-bearing guide, 568x568x75 mm

96,50
EUR



873.7014-R010P
Compartment with ball-bearing guide, 790x568x75 mm

113,50
EUR



873.7014-R009P
Compartment with logo and ball-bearing guide, 790x568x154 mm

200,50
EUR



873.7014-R007P
Storage for compartments

23,50
EUR



873.7014-R002P
Can holder including screws, W = 445 mm

42,90
EUR



873.7014-R015P
Paper roll holder including screws, W= 400 mm

29,90
EUR



873.7014-R004P
M8 screws (16 pcs.)

7,50
EUR



873.7014-R003P
M6x12 screw (1 pcs.)

0,50
EUR



873.7014-R001P
Body of workshop trolley attachment

1.355,90
EUR



EACH TROLLEY IS UNIQUE

**Tool holders, pipe holders, storage shelves,
magnetic shells, clamps, holders and hooks:
The extensive range of accessories for
Performance Plus fulfils every wish and turns
your workshop trolley into your personal
one-of-a-kind piece. Extend your performance!**

**FREELY CONFIGURABLE –
EVEN AFTER PURCHASING**

**Fully tailored
to your needs**

**HOLDERS FOR ALL
TYPES OF TOOLS**

ACCESSORIES

- Accessories suitable for hole measurements
10 x 10 mm – hole distance 38 mm
- fixing screws included
- baseplate thickness 1.5 mm
- galvanised steel plate



860.0855
Pipe holder, Ø 60mm

4,50
EUR



860.0856
Pipe holder, Ø 100mm

7,50
EUR



860.0857
Storage shelf without partition,
350x125mm

22,50
EUR



860.0858
Storage shelf without partition,
450x150mm

38,50
EUR



860.0859
Lin bin holder single, size 7+8

3,50
EUR



860.0870
Universal tool holder self drill,
390x45mm

33,50
EUR



860.0871
Universal tool storage box,
55x310x125mm

42,90
EUR



860.0878
Sheet steel tray, 435x250mm

36,50
EUR



860.0873
Socket holder, 9 holes, 390x30mm

19,50
EUR



860.0879
Paper roll holder, 355mm

19,50
EUR



860.0880
Document holder, 220x310mm

29,90
EUR



860.0881
Works order holder, 220x310mm

25,90
EUR



860.0886
Drill holder for MK 2 and MK 3
shafts, 16 holes

23,50
EUR



18,50
EUR

860.0882
Magnet set, Ø 25mm, red, pack of 10



20,50
EUR

860.0883
Magnet set, Ø 25mm, green, pack of 10



18,50
EUR

860.0884
Magnet set, Ø 25mm, blue, pack of 10



8,50
EUR

860.0887
Bit holder, 7 holes, 150x35mm



10,90
EUR

860.0872
Hexagon socket holder, 11 holes, 145x70mm



25,90
EUR

860.0894
Socket holder for 1/2" sockets, 6 holes



40,90
EUR

860.0895
Socket holder for 1/2" sockets, 13 holes



2,90
EUR

860.0801
Tool holder with straight end Ø 6mm, 50mm



2,50
EUR

860.0802
Tool holder with straight end Ø 6mm, 100mm



2,50
EUR

860.0803
Tool holder with straight end Ø 6mm, 150mm



2,50
EUR

860.0820
Double tool holder with straight end Ø 6mm, 35mm



2,90
EUR

860.0821
Double tool holder with straight end Ø 6mm, 50mm



3,50
EUR

860.0822
Double tool holder with straight end Ø 6mm, 75mm



2,50
EUR

860.0804
Tool holder with angled hook end Ø 6mm, 50mm



2,50
EUR

860.0805
Tool holder with angled hook end Ø 6mm, 100mm



2,50
EUR

860.0806
Tool holder with angled hook end Ø 6mm, 150mm



3,50
EUR

860.0807
Tool holder with angled hook end Ø 6mm, 200mm



2,90
EUR

860.0812
Double tool holder with angled hook end, Ø 6 mm, 35mm



2,90
EUR

860.0813
Double tool holder with angled hook end, Ø 6 mm, 50mm



3,50
EUR

860.0814
Double tool holder with angled hook end, Ø 6 mm, 75mm



3,50
EUR

860.0815
Double tool holder with angled hook end, Ø 6 mm, 150mm



2,50
EUR

860.0809
Tool holder with vertical hook end Ø 6mm, 35mm



2,50
EUR

860.0810
Tool holder with vertical hook end Ø 6mm, 75mm



2,50
EUR

860.0811
Tool holder with vertical hook end Ø 6mm, 125mm

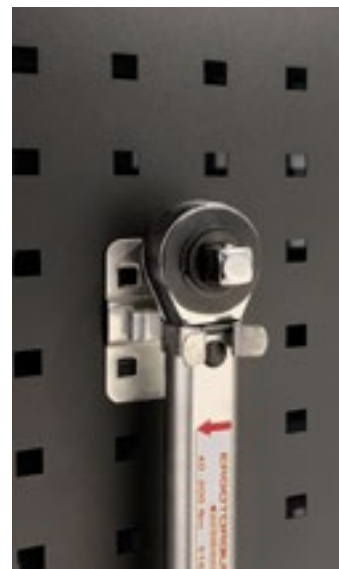
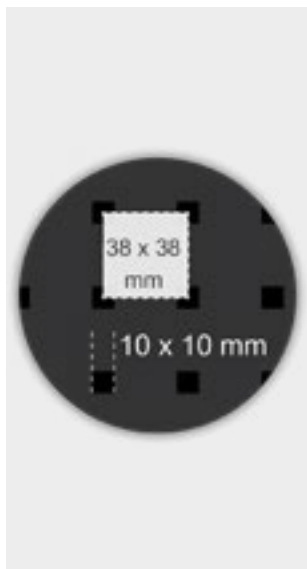

860.0816
Double tool holder with vertical hook end, Ø 6 mm, 35mm



860.0817
Double tool holder with vertical hook end, Ø 6 mm, 50mm



860.0818
Double tool holder with vertical hook end, Ø 6 mm, 75mm



860.0819
Double tool holder with vertical hook end, Ø 6 mm, 150mm



860.0824
Tool clip, single small, Ø 6mm



860.0825
Tool clip, single small, Ø 10mm



860.0826
Tool clip, single small, Ø 13mm



860.0827
Tool clip, single small, Ø 16mm



860.0828
Tool clip, single small, Ø 19mm



860.0829
Tool clip, double small, Ø 6mm



860.0830
Tool clip, double small, Ø 10mm



860.0831
Tool clip, double small, Ø 13mm



860.0832
Tool clip, double small, Ø 16mm



860.0833
Tool clip, double small, Ø 19mm



860.0834
Tool clip, single large, 25mm



860.0835
Tool clip, single large, 28mm

P 10

P 15

P 20

P 25

P 30

P 35

P 40

P 45

Individual parts

Accessories

ACCESSORIES



860.0836
Tool clip, single large, 32mm

3,50
EUR



860.0823
Angled hook for nuts and sockets
Ø 6mm

3,50
EUR



860.0837
Pliers holder depth 20mm, 35mm

2,50
EUR



860.0838
Pliers holder depth 20mm, 55mm

2,50
EUR



860.0839
Pliers holder depth 20mm, 75mm

4,50
EUR



860.0840
Round holder, 25x65mm

3,50
EUR



860.0841
Power tool holder, Ø 40mm

3,50
EUR



860.0842
Power tool holder, Ø 60mm

3,50
EUR



860.0843
Power tool holder, Ø 80mm

4,50
EUR



860.0844
Tool holder 3 way, Ø 6mm, 150mm

5,50
EUR



860.0874
Cable holder, 150mm

4,50
EUR



860.0875
Cable holder, 200mm

5,50
EUR



860.0876
Tool holder for euro blister
packaging, 125mm

3,50
EUR



860.0877
Tool holder for euro blister
packaging, 150mm

4,50
EUR



860.0845
Six way tool holder hook ends 45°
angled

8,50
EUR



860.0860
Base plate, small

1,50
EUR



860.0861
Base plate, large

2,50
EUR



860.0862
Lin bin holder, 550x40mm

19,50
EUR



22,50
EUR

860.0863
Lin bin holder, 550x60mm



13,90
EUR

860.0864
Spanner holder tapered for 10 spanners, 145mm



18,50
EUR

860.0865
Spanner holder tapered for 10 spanners, 225mm



8,50
EUR

860.0866
Can holder Ø 70mm, 100mm



19,50
EUR

860.0867
Can holder Ø 70mm, 300mm



25,90
EUR

860.0868
Pipe holder 230x70mm



8,50
EUR

860.0847
Small component tray with partition, 150x55mm



9,90
EUR

860.0848
Small component tray without partition, 150x55mm



11,90
EUR

860.0869
Universal tool holder self drill, 120x70mm



5,50
EUR

860.0846
Combination holder 150x55mm



8,50
EUR

860.0849
Spanner holder horizontal, 8 holes



7,50
EUR

860.0850
Screwdriver holder, 6 holes, 150x55mm



13,90
EUR

860.0851
Screwdriver holder, 12 holes, 150x55mm



9,90
EUR

860.0852
Drill- and hexagon socket holder, 14 holes



19,50
EUR

860.0853
Drill- and hexagon socket holder, 28 holes



7,50
EUR

860.0854
Saw holder, 4 holes, 150mm

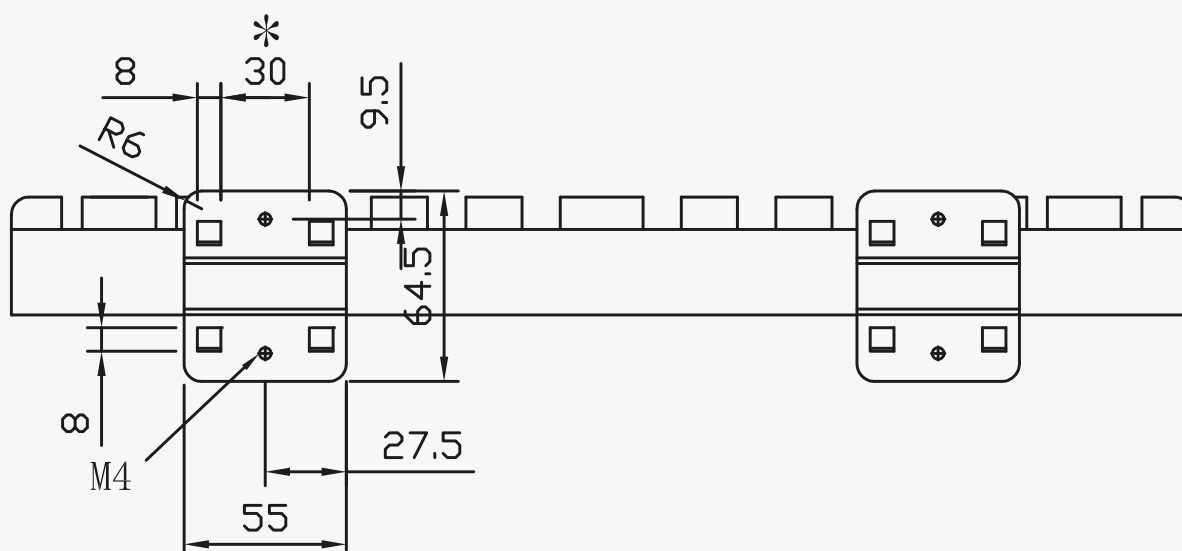

HIDE YOUR TREASURE UNDER THE HOOD

If you work with Performance Plus, you probably aren't interested in knocking off work so quickly. But when the time does come, you can cover your workshop trolley with the matching hood to protect it from dust and scratches.

**CUSTOMISED FOR
YOUR WORKSHOP TROLLEY**

**Robust protection
in a few steps**

MATCHING DESIGN

FOR ALL SIZES



P10

P10TC

P15

P20

P25

P30

P35

P45

P 10

P 15

P 20

P 25

P 30

P 35

P 40

P 45

Individual parts

Accessories

HOODS



873.0010
Cover for workshop trolley P10,
853x527x849 mm

32,50
EUR



873.0015
Cover for workshop trolley P15,
845x516x848 mm

32,50
EUR



873.0020
Cover for workshop trolley P20,
1067x646x848 mm

42,90
EUR



873.0025
Cover for workshop trolley P25,
1040x517x849 mm

32,50
EUR



873.0030
Cover for workshop trolley P30,
1075x657x849 mm

32,50
EUR



873.0035
Cover for workshop trolley P35,
1232x741x852 mm

42,90
EUR



873.0040
Cover for workshop trolley P40,
1701x710x829 mm

48,50
EUR



873.0045
Cover for workshop trolley P45,
1701x710x944 mm

48,50
EUR

www.myperformanceplus.de

www.kstools.com



Your businesspartner:



KS Tools Werkzeuge - Maschinen GmbH
Seligenstädter Grund 10-12
63150 Heusenstamm
Deutschland
Tel.: +49 (0)6104 4974-0
Fax: +49 (0)6104 4974-11
E-Mail: info@kstools.de
www.myperformanceplus.de



4 042146 866634

LL21-01EN_EUR

All prices plus VAT. With the publication of this catalog, all previous prices are no longer valid.
Sale only to specialist dealers. Subject to misprints, mistakes and technical changes. Prices valid until September 30, 2023